



Institute of Transport Economics
Norwegian Centre for Transport Research



Safety in bus transport in Europe

Status of safety and discussion of measures benefitting drivers, passengers and other road users

Tor-Olav Nævestad, Alena Katharina Høye, Rune Elvik

1984/2023



Title:	Safety in bus transport in Europe : Status of safety and discussion of measures benefitting drivers, passengers and other road users
Tittel:	Trafikksikkerhetstiltak i busstransport i Europa: Status for sikkerhet og diskusjon av tiltak til fordel for sjåførere, passasjerer og andre trafikanter
Author:	Tor-Olav Nævestad, Alena Katharina Høye, Rune Elvik
Date:	09.2023
TØI Report:	1984/2023
Pages:	64
ISSN Electronic:	2535-5104
ISSN Print:	0808-1190
ISBN Electronic:	978-82-480-2046-2
ISBN Print:	978-82-480-2047-9
Funded by:	Kollektivtrafikkforeningen
Project:	5378 – Kollektivtrafikkforeningen
Project Manager:	Tor-Olav Nævestad
Quality Manager:	Trine Dale
Research Area:	Safety, Security and Resilience
Keywords:	Road safety, bus transport, safety management, procurers

Summary

This report provides an overview on the status of road safety in bus transport and potential measures for improving traffic safety in bus transport, for drivers, passengers and road users outside the bus. We seek to provide decision-makers and procurers with a foundation for setting effective and relevant requirements for enhanced traffic safety. We recommend that the following measures are made mandatory in bus transport: 1) Fleet management systems to facilitate soft driving style, 2) Safety culture measures, 3) Safety management systems, 4) Crash protection for bus drivers. These measures are not legally required in bus transport, although they are highly effective for preventing accidents. Other measures are already required, but not fully implemented in practice. Given their efficiency, a relevant step would be to find measures aiming to increase their implementation. This applies e.g., to increase seat belt use among passengers in class 3 og 2 buses. There are also several measures which seem promising, but for which there is little relevant research, e.g., geofence speed limiter.

Kort sammendrag

Rapporten gir en oversikt over status for trafikksikkerhet i busstransport og potensielle tiltak for å bedre trafikksikkerheten for førere og passasjerer i buss, samt for trafikanter utenfor bussen. Rapporten skal gi beslutningstakere og innkjøpere et grunnlag for å stille effektive og relevante krav til økt trafikksikkerhet. Vi anbefaler at følgende tiltak gjøres obligatoriske i busstransport: 1) Flåtestyringssystemer for å legge til rette for myk kjørestil, 2) Sikkerhetskulturtiltak, 3) Sikkerhetsstyringssystemer, 4) Kollisjonsvern for bussjåførere. Disse tiltakene er ikke lovpålagt i busstransport, selv om de er svært effektive for å forebygge ulykker. Andre tiltak er allerede påkrevd, men ikke fullt ut implementert i praksis. Gitt deres effektivitet, er det relevant å finne tiltak som tar sikte på å øke implementeringen. Dette gjelder f.eks. å øke bilbeltebruken blant passasjerer i klasse 3 og 2 busser. Det er også flere tiltak som virker lovende, men som det er lite relevant forskning på, f.eks. geofence fartsbegrenser.



Preface

Transport by bus and coach is the safest mode of road travel in Europe (European Commission 2022). However, data from recent years indicate that around 500 people are killed annually in road accidents involving buses in Europe. Statistics from 2015 indicate 30 000 annual personal injuries in bus accidents in Europe (European Commission 2022). Recent incidents in Norway have indicated that buses do not provide sufficient collision protection for bus drivers in case of accidents, and that bus accidents therefore may become fatal for bus drivers, even at lower speeds. This and other trends (e.g. data on passengers' fall accidents onboard) have brought bus safety on the agenda.

This project seeks to contribute to ensuring that no one is killed or seriously injured in bus transport on European roads, by increasing traffic safety in bus transport in general for drivers, passengers and road users who interact with buses. The present report seeks to achieve this by providing knowledge about the status of road safety in bus transport, and by providing a systematic list of relevant safety measures in bus transport, thereby triggering new road safety measures in bus transport, which will soon become standard in Europe. This applies to both technical measures and measures relating to safety management, learning and safety culture.

The report has been written on behalf of Public Transport Norway – the Norwegian Association of Public Transport Authorities. (Kollektivtrafikkforeningen). The contact person at Public Transport Norway has been Daniel Rees. We are very grateful for good cooperation and interesting discussions during the project. The project has also had a project group consisting of members of the Public Transport Norway, made up of different stakeholders within the field of public transport in Norway. We are very grateful for good input and interesting discussions. It has been conducted interviews and discussions with procurers of public transport in the project, and we are very grateful to the people who contributed.

Project manager at TØI has been Tor-Olav Nævestad. He has had the main responsibility for writing the report. Alena Høye and Rune Elvik have been project staff. They have written about measures and helped rank their importance. Alena Høye has also contributed to conducting interviews and Rune Elvik has also written about bus accidents, exposure and risks in Norway. Chief researcher Marianne Stølan Rostoft has quality assured the report. Trude Kvalsvik has prepared the report for publication.

Oslo, September 2023
Institute of Transport Economics

Bjørne Grimsrud
Managing Director

Trine Dale
Director of Research



Contents

Summary

Sammendrag

1	Introduction	1
1.1	Background	1
1.2	Aims	2
2	Method	3
2.1	Status of traffic safety in bus transport	3
2.2	Literature review	3
2.3	Interviews.....	4
3	Overview of the traffic safety situation	6
3.1	Accidents with buses in Europe	6
3.2	Accident risk in bus transport in Norway.....	7
3.3	Incidents reported to Norway’s largest transit authority.....	12
4	Organizational measures	15
4.1	Safety management systems	15
4.2	Measures to improve safety culture	17
4.3	Fleet management systems	19
5	On-board passenger safety	22
5.1	Seat belts for passengers	22
5.2	Design of passenger seat backs	24
5.3	Crash-friendly design and positioning of handrails	25
5.4	Securing wheelchairs and baby buggies	25
5.5	Measures to prevent fall accidents.....	26
6	Crashworthiness and driver protection	28
6.1	Crashworthiness in head-on collisions and run-off-road crashes	28
6.2	Increasing seat belt use among bus drivers.....	31
7	Crash protection for vulnerable road users	32
7.1	Front-end design	33
7.2	Run-over guards and pedestrian airbags.....	34
7.3	Remove side mirrors.....	34
8	Driver assistance systems – mandatory systems	35
8.1	Top speed limiter	35
8.2	Intelligent speed assistance (ISA) – Warning ISA.....	35
8.3	Reversing detection	36
8.4	Blind spot monitoring and warning systems	37

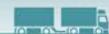

8.5	Driver distraction warning	38
8.6	Event data recorder	38
8.7	VRU-collision warning and automatic emergency brake (AEB).....	39
8.8	Emergency stop signal	40
8.9	Tyre-pressure warning.....	40
9	Driver assistance systems – optional systems.....	41
9.1	Electronic stability control (ESC) and roll stability control (RSC)	41
9.2	Non-overrideable ISA.....	41
9.3	Geofence speed limiter.....	42
9.4	Alcolock and “druglock”	42
9.5	Lane Departure Warning (LDW).....	43
9.6	Forward collision warning (FCW) and automatic emergency brake (AEB).....	44
9.7	Pedal application error avoidance	44
9.8	Runaway bus prevention	45
9.9	Connected traffic and weather warnings	45
10	Other measures	46
10.1	Improved visibility of buses	46
10.2	Studded tires.....	46
10.3	Technical defects and control.....	47
10.4	Evacuation from buses after accidents.....	47
11	Summary and discussion	48
11.1	Ranking of measures.....	48
11.2	Ranking of measures within categories.....	48
11.3	Limitations	49
11.4	Recommendations	49
	References	51
	Appendix	57
	Appendix 1. Overview of assessed measures.....	57
	Appendix 2. Interview results	61

Safety in bus transport in Europe

Status of safety and discussion of measures benefitting drivers, passengers and other road users

TØI Report 1984/2023 • Authors: Tor-Olav Nævestad, Alena Katharina Høye, Rune Elvik • Oslo 2023 • 64 pages

This report provides an overview on the current status of road safety in bus transport and potential measures for improving traffic safety in bus transport; for drivers, passengers and road users outside the bus. The report aims to provide decision-makers and procurers with a basis for setting effective and relevant requirements for enhanced traffic safety. We recommend that the following measures are made mandatory in bus transport: 1) Fleet management systems to facilitate a soft driving style, 2) Safety culture measures, 3) Safety management systems, 4) Crash protection for bus drivers. These measures are not legally required in bus transport, although they are highly effective for preventing accidents. Safety culture measures and Safety management systems are required in other transport sectors, with a high safety level (e.g., aviation, rail, maritime sector). Other measures are already required, but not fully implemented in practice. Given their efficiency, a relevant step would be to find measures aiming to increase their implementation. This applies e.g., to measures to increase seat belt use among passengers in class 3 and 2 buses. Additionally, there are also several measures which seem promising, but for which there is little relevant research, or the current versions of the technology might not seem fully developed yet, indicating a need for further research. This applies e.g., to geofence speed limiter, warning systems for vulnerable road users and emergency braking, run over guards and pedestrian airbags, measures to prevent fall accidents on-board buses, measures to secure wheelchairs and baby buggies.

Background

Travel by public transport – bus, train or tram – is very safe and perceived to be so. In recent years, several bus drivers have, however, been involved in serious accidents on Norwegian roads, under conditions which should not indicate serious outcomes. Recent reports indicate that large numbers of passengers are injured in incidents onboard buses. Additionally, there is a societal shift to both increased bus transport in cities as well as an increase in vulnerable transport modes, e.g. walking, cycling, e-scooters etc. which might lead to an increase in conflicts between buses and vulnerable road users in cities

Aims

The study seeks to develop an overview on the status and potential measures for improving driver and traffic safety in buses. The report will provide decision-makers and procurers with a foundation for setting effective and relevant requirements for enhanced traffic safety. The aims of the study are to provide:

- 1) An overview of the traffic safety situation and historical accident statistics for bus transport in Norway and Europe.
- 2) Description of the necessary safety management systems and safety culture features required to improve traffic safety in bus transport.
- 3) Overview of measures to reduce the occurrence of accidents, including estimated effectiveness of these measures where possible.
- 4) Overview of potential measures to reduce the consequences of accidents, including estimated effectiveness of these measures where possible.
- 5) Rating of the measures, based on whether they lead to reductions in accidents, uncertainty, and relevance.

Methods

We have used three methods in the study: 1) Data on road accidents, incidents, and exposure to calculate the frequency and risk of accidents and incidents in bus transport, 2) Interviews and informal discussions with key stakeholders to map the state of the art of bus safety measures, 3) Literature review to summarize available knowledge about the safety effects of measures to improve safety in bus transport. The measures are divided into the following categories: organisational measures, measures addressing onboard passenger safety, crashworthiness and driver protection, crash protection for vulnerable road users, driver assistance systems – mandatory systems, driver assistance systems – optional systems and other measures. Thirty-three specific measures are reviewed.

In the review of each measure identified in the literature review, we address the following questions: 1) Has the measure been studied in buses? 2) Does the measure reduce accidents or injuries? 3) Who benefits from the reduction in accidents or injuries? 4) How uncertain is the effect? 5) Does the measure conflict with other objectives? 6) Is the measure relevant to the traffic safety situation? We rank the measures based on effectiveness, using an evaluation where we assign points for each of the mentioned questions. Based on these calculations, we calculate a total score for each measure. The knowledge about each measure is summarized in six points in the form of a table in the following format (*Table 2.1*).

Table S.1: Qualitative and quantitative criteria for assessment of measures in the literature review.

	Measure studied on buses?	Does the measure reduce accidents / injuries?	Target group of road users	How uncertain is the effect?	Is the measure in conflict with other measures?	Is the measure relevant?
Qualitative assessment	Yes / No	Yes, a reduction of A-B percent / No	Persons within bus / Other road users	High / Medium / Low	Yes, in which case which measures / No	Yes / No / Maybe
Quantitative assessment	0: No / 1: No, but in other relevant cases / 2: Yes	0: No / 1: Yes, most likely / 2: Yes, small effect / 3: Yes, large effect	Driver / Vulnerable road users / Other road users / Passengers / All	1: High / 2: Medium / 3: Low	-1: Yes / 0: No / +1: No, and other benefits (e.g. reduced omissions)	0: No / 1: Yes, maybe / 2: Yes, to some extent / 3: Yes, to a large extent



Results

Traffic safety situation. The first aim is to provide an overview of the traffic safety situation and historical accident statistics for bus transport in Norway and Europe. European data indicates that between the years 2010 and 2019, the number of fatalities in crashes involving buses/coaches has decreased by 34%. There is a high proportion of vulnerable road users (37%), especially pedestrians (29%) in bus accidents, probably because of the urban environment in which many buses operate. Norwegian data shows that the risk of injury to bus drivers in road accidents has declined over time. The same applies to bus passengers. Bus drivers have about the same risk of injury as car drivers, but a higher risk of injury than bus passengers. Moreover, bus passenger injuries are very incompletely reported. Most injuries to passengers do not result from traffic accidents, but from events onboard and when going on/off bus. These events represent 80-85 % of all injuries to bus passengers. We analyse such incidents based on reports to Norway's largest transit authority, Ruter.

Organisational management measures. The second aim of the study is to provide a description of the necessary safety management systems and safety culture features required to improve traffic safety in bus transport. Safety management systems consist of formal procedures and measures that enable organizations to work systematically with safety, such as identifying risks through formal risk analyses, developing and implementing corrective measures (e.g., procedures, training), defining roles and responsibilities, regularly monitoring status, tracking various safety indicators (KPIs), and implementing corrective measures if necessary (Thomas, 2012). Safety management systems denote the formal aspects of safety management in organisations. The informal aspects of safety, or "what people actually do," are related to safety culture. Safety culture refer to shared and safety relevant ways of thinking and acting (Nævestad 2010). It is mostly measured as management (and employee) commitment to safety and perceptions of whether aspects of safety management systems are "alive" and relevant. For safety management systems to be effective, they must be combined with, or used as a tool to create a good safety culture (Nævestad et al., 2018b).

There is generally less focus on safety culture and safety management in the road sector compared to other transport sectors. This is explained by the fact that road sector companies do not have the same legal requirements for safety management systems as in aviation, maritime sector, and railways. Despite legal requirements, several bus companies work systematically with safety management systems and safety culture, and our research indicates that this is related to positive safety outcomes. The same applies to another organisational safety management measure; working systematically with fleet management systems to ensure a soft driving style. This measure is related to positive safety outcomes, and it is relevant for several different types of injuries in bus transport, both applying to traffic accidents and non-collision passenger incidents onboard the bus. An important aim of the study is to rate the measures, based on whether they lead to reductions in accidents, uncertainty, and relevance. The organisational management measures are among the bus safety measures with the highest overall rating: Fleet management system is rated as number one, safety culture measures as number three and safety management system as number seven.

Measures to reduce the occurrence of accidents. The third aim is to provide an overview of measures to reduce the occurrence of accidents, including estimated effectiveness of these measures where possible. The five most effective and relevant measures studied (ranked according to their score), in addition to the three mentioned organisational measures are: blind spot warning and measures for improved visibility.

Measures to reduce the consequences of accidents. The fourth aim is to provide an overview of potential measures to reduce the consequences of accidents, including estimated

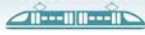

effectiveness of these measures where possible. The five most effective and relevant measures studied are, ranked according to their score: seat belt in class 3 buses, measures to increase seat belt use for bus drivers, seat belt in class 2 buses, crash protection for bus drivers and seat belt in class 1 buses.

Limitations

It should be mentioned that our rating and assessment of measures, based on whether they lead to reductions in accidents, uncertainty, and relevance (i.e. fifth aim), is conservative and biased in the sense that we tend to rate existing and “older” measures higher. The reason is that there is more research on older measures, and thus more information on effects on accidents, less uncertainty, more well developed and user friendly technology etc. We attempt to compensate for this bias by also highlighting measures which seem promising, but for which there is little relevant research, indicating need for future research.

Recommendations

Many of the measures that we rate are already legally required in bus transport and are thus implemented in companies. We rate them nevertheless, to provide an overview of efficiency and relevance. Several measures that are legally required get high ratings in our assessments. It is, however, of more relevance to provide recommendations based on efficient and relevant measures that are not legally required (yet), and which thus are not fully implemented. When it comes to such measures, some companies might have them, but not all, as the measures are not mandatory. Based on that, we recommend that the following measures are made mandatory in bus transport: 1) Fleet management systems to facilitate a soft driving style, 2) Safety culture measures, 3) Safety management systems, 4) Crash protection for bus drivers. These measures are not legally required in bus transport, although they are highly effective for preventing accidents. Safety culture measures and Safety management systems are required in other transport sectors, with a high safety level (e.g. aviation, rail, maritime sector). Measure 1-3 should be required by public transport authorities through contracts with bus operators. When it comes to measure 4, we recommend a separate European standard for collision safety in buses (instead of the current situation, which involves that buses are covered by regulations for other types of vehicles).

Other measures are already required, but not fully implemented in practice. Given their efficiency, a relevant step would be to find measures aiming to increase their implementation. This applies e.g. to measures to increase seat belt use among passengers in class 3 and 2 buses. This could be done by both national authorities and public transport authorities.

Additionally, there are also several measures which seem promising, but for which there is little relevant research, or the current versions of the technology might not seem fully developed yet. This indicates a need for further research. This applies e.g. to geofence speed limiter, run over guards, warning systems for vulnerable road users and emergency braking, pedestrian airbags, measures to prevent fall accidents on-board buses, measures to secure wheelchairs and baby buggies. These measures need to be further developed and examined by a range of key stakeholders in bus transport.

Trafikksikkerhetstiltak i busstransport i Europa

Status for sikkerhet og diskusjon av tiltak til fordel for sjåførere, passasjerer og andre trafikanter

TØI rapport 1984/2023 • Forfattere: Tor-Olav Nævestad, Alena Katharina Høye, Rune Elvik • Oslo, 2023 • 64 sider

Denne rapporten gir en oversikt over status for trafikksikkerhet i busstransport, og potensielle tiltak for å bedre trafikksikkerheten i buss; for sjåførere, passasjerer og trafikanter rundt bussen. Rapporten skal gi beslutningstakere og innkjøpere et grunnlag for å stille effektive og relevante krav til økt trafikksikkerhet. Vi anbefaler at det stilles krav til at følgende tiltak blir obligatoriske i busstransport: 1) Flåtestyringssystemer for å legge til rette for myk kjørestil, 2) Sikkerhetskulturtiltak, 3) Sikkerhetsstyringssystemer, 4) Kollisjonsvern for bussjåførere. Disse tiltakene er ikke lovpålagt i busstransport, selv om de er svært effektive for å forebygge ulykker. Sikkerhetskulturtiltak og sikkerhetsstyringssystemer kreves i andre transportsektorer, med høyt sikkerhetsnivå (f.eks. luftfart, jernbane, maritim sektor). Andre tiltak er allerede påkrevd, men ikke fullt ut implementert i praksis. Gitt deres effektivitet, er det relevant å finne tiltak som tar sikte på å øke implementeringen. Dette gjelder f.eks. å øke bilbeltebruken blant passasjerer i klasse 3 og 2 busser. I tillegg er det også flere tiltak som virker lovende, men som det er lite relevant forskning på, eller så er det slik at de nåværende versjonene av teknologien kanskje ikke er fullt utviklet ennå. Dette gjelder f.eks. geofence fartsbegrensere, varslingssystemer for myke trafikanter og nødbrems, overkjøringshinder og kollisjonsputer for fotgjengere, tiltak for å hindre fallulykker om bord i busser, tiltak for å sikre rullestoler og barnevogner. Dette er tema som indikerer behov for ytterligere forskning.

Bakgrunn

Å reise med offentlig transport – buss, tog eller trikk – er veldig trygt og oppfattes som det. De siste årene har imidlertid flere bussjåførere vært involvert i alvorlige ulykker på norske veier, under forhold som ikke skulle tilsi alvorlige utfall. Nylige rapporter tyder på at et stort antall passasjerer skades i hendelser ombord på busser. I tillegg tilsier ønskede samfunnsendringer økt busstransport i byer, samt en økning i myke transportformer, f.eks. gange, sykling, e-scootere etc., som kan føre til økning i konflikter mellom busser og myke trafikanter i byer.

Mål

Studien har som mål å utvikle en oversikt over status og potensielle tiltak for å bedre sjåfør- og trafikksikkerhet i busstransport. Rapporten skal gi beslutningstakere og innkjøpere et grunnlag for å stille effektive og relevante krav til økt trafikksikkerhet. Målene med studien er å gi:

- 1) En oversikt over trafikksikkerhetssituasjonen og historisk ulykkesstatistikk for busstransport i Norge og Europa.
- 2) Beskrivelse av nødvendige sikkerhetsstyringsystemer og sikkerhetskulturtrekk som kreves for å forbedre trafikksikkerheten i busstransport.
- 3) Oversikt over tiltak for å redusere forekomsten av ulykker, inkludert estimert effektivitet av disse tiltakene der det er mulig.
- 4) Oversikt over potensielle tiltak for å redusere konsekvensene av ulykker, inkludert estimert effektivitet av disse tiltakene der det er mulig.
- 5) Vurdering av tiltakene, basert på om de fører til reduksjoner i ulykker, usikkerhet og relevans.

Metoder

Vi har brukt tre metoder i studien: 1) Data om trafikkulykker, hendelser og eksponering for å beregne forekomst av ulykker og risiko for ulykker og hendelser i busstransport, 2) Intervjuer og uformelle diskusjoner med sentrale interessenter for å kartlegge «state of the art» for sikkerhetstiltak i busstransport, 3) Litteraturgjennomgang for å oppsummere tilgjengelig kunnskap om sikkerhetseffekter av tiltak for å bedre sikkerheten i busstransport. Tiltakene er delt inn i følgende kategorier: organisatoriske tiltak, tiltak for passasjersikkerhet om bord, kollisjonssikkerhet og førerbeskyttelse, kollisjonsvern for myke trafikanter, førerstøttesystemer – obligatoriske systemer, førerstøttesystemer – valgfrie systemer og andre tiltak. Trettitue tiltak gjennomgås.

I gjennomgangen av hvert enkelt tiltak identifisert i litteraturgjennomgangen tar vi opp følgende spørsmål: 1) Er tiltaket studert i buss? 2) Reduserer tiltaket ulykker eller skader? 3) Hvem tjener på reduksjonen i ulykker eller skader? 4) Hvor usikker er effekten? 5) Er tiltaket i konflikt med andre mål? 6) Er tiltaket relevant for trafikksikkerhetssituasjonen? Vi rangerer tiltakene ut fra effektivitet, gjennom en evaluering der vi tildeler poeng for hvert av de nevnte spørsmålene. Basert på disse beregningene beregner vi en totalscore for hvert tiltak. Kunnskapen om hvert tiltak er oppsummert i seks punkter i Tabell S.1:

Tabell S.1: Kvalitative og kvantitative kriterier for vurdering av tiltak i litteraturgjennomgangen.

	Er tiltaket studert i buss?	Gir tiltaket færre ulykker eller skader?	Hvem oppnår færre ulykker eller skader?	Hvor usikker er virkningen?	Kommer tiltaket i konflikt med andre mål?	Er tiltaket relevant for skadebildet?
Kvalitativ vurdering	Ja eller nei	Ja, en nedgang på A-B prosent; eller nei	Personer i buss; andre trafikanter	Stor, middels, liten usikkerhet	Ja, i så fall hvilke; eller nei	Ja, nei, kanskje.
Kvantitativ vurdering	0: nei, 1: nei, men i andre relevante 2: ja	0: nei, 1: ja, sannsynligvis, 2: ja, effekt for noen (ulykker/personer), 3: Ja, effekt for mange	Sjåfør, myke trafikanter, øvrige trafikanter, passasjerer (alle grupper)	1: stor, 2: middels, 3: liten	-1: ja, 0: nei, +1: også andre fordeler (for eksempel mindre utslipp)	0: nei, 1: ja, kanskje, 2: ja, i noen grad, 3: ja, i stor grad

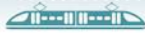

Resultater

Trafikksikkerhetssituasjon. Det første målet er å gi en oversikt over trafikksikkerhetssituasjonen og historisk ulykkesstatistikk for busstransport i Norge og Europa. Europeiske data indikerer at antall omkomne i ulykker med busser har gått ned med 34% mellom 2010 og 2019. Det er en høy andel myke trafikanter (37%), spesielt fotgjengere (29%) i bussulykker, trolig på grunn av at mange busser kjører i by. Norske data viser at bussjåførers risiko for personskadeulykker i trafikken har blitt sterkt redusert over tid. Det samme gjelder busspassasjerers risiko. Bussjåfører har omtrent samme risiko for å bli involvert i personskadeulykker som bilførere, men høyere risiko for skade enn busspassasjerer. Dessuten er skader på busspassasjerer svært ufullstendig rapportert. De fleste skader på passasjerer skyldes ikke trafikkulykker, men hendelser om bord og ved på- eller avstigning av bussen. Disse hendelsene utgjør 80-85% av alle skader på busspassasjerer. Vi analyserer slike hendelser basert på rapporter til Norges største kollektivtransportforvalter, Ruter.

Organisatoriske ledelsestiltak. Det andre målet med studien er å gi en beskrivelse av sikkerhetsstyringssystemer og sikkerhetskulturtrekk som er nødvendige for å forbedre trafikksikkerheten i busstransport. Sikkerhetsstyringssystemer består av formelle prosedyrer og tiltak som gjør organisasjoner i stand til å arbeide systematisk med sikkerhet, som å identifisere risikoer gjennom formelle risikoanalyser, utvikle og implementere korrigerende tiltak (f.eks. prosedyrer, opplæring), definere roller og ansvar, regelmessig overvåking av status, følge ulike sikkerhetsindikatorer (KPIer) (Thomas, 2012). Sikkerhetsstyringssystemer betegner de formelle aspektene ved sikkerhetsstyring i organisasjoner. De uformelle aspektene ved sikkerhet, eller «hva folk faktisk gjør», er knyttet til sikkerhetskultur. Sikkerhetskultur refererer til felles og sikkerhetsrelevante måter å tenke og handle på (Nævestad 2010). Sikkerhetskultur måles gjerne kvantitativt som ledelsens (og ansattes) engasjement for sikkerhet og oppfatninger om hvorvidt aspekter ved sikkerhetsstyringssystemer er "levende" og relevante.

Det er generelt mindre fokus på sikkerhetskultur og sikkerhetssystemer i vegsektoren sammenlignet med andre transportsektorer. Årsaken er at transportbedrifter i vegsektoren ikke har de samme lovkravene til sikkerhetsstyringssystemer som innen luftfart, maritim sektor og jernbane. Til tross for manglende lovkrav jobber flere busselskaper systematisk med sikkerhetsstyringssystemer og sikkerhetskultur, og vår forskning tyder på at dette er knyttet til positive sikkerhetsresultater. Det samme gjelder et annet organisatorisk sikkerhetsstyringstiltak; systematisk arbeid med flåtestyringssystem for å legge til rette for en myk kjørestil, som er sikker og økonomisk. Dette tiltaket er knyttet til positive sikkerhetsutfall, og det kan forebygge flere ulike hendelser i busstransport, både trafikkulykker og passasjerskader om bord i bussen som ikke skyldes trafikkulykker. Et viktig mål med studien er å vurdere tiltakene ut fra om de fører til reduksjoner i ulykker, usikkerhet og relevans. De organisatoriske ledelsestiltakene er blant sikkerhetstiltakene med høyest samlet vurdering: Flåtestyringssystem er rangert som nummer én, sikkerhetskulturtiltak som nummer tre og sikkerhetsstyringssystem som nummer syv.

Tiltak for å redusere forekomsten av ulykker. Det tredje målet er å gi en oversikt over tiltak for å redusere forekomsten av ulykker, inkludert estimere effekt av disse tiltakene på ulykker der det er mulig. De fem mest effektive og relevante tiltakene som er studert (rangert etter poeng for effekt og relevans), i tillegg til de tre nevnte organisatoriske tiltakene er: blindsonervarsling og tiltak for bedre sikt.

Tiltak for å redusere konsekvensene av ulykker. Det fjerde målet er å gi en oversikt over mulige tiltak for å redusere konsekvensene av ulykker, inkludert estimere effekt av disse tiltakene på ulykker der det er mulig. De fem mest effektive og relevante tiltakene som vi diskuterer er (rangert etter poeng for effekt og relevans): bilbelte i klasse 3-busser, økende

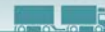

bilbeltebruk for bussjåførere, bilbelte i klasse 2-busser, kollisjonsvern for bussjåførere og bilbelte i klasse 1-buss

Begrensninger

Det bør nevnes at vår vurdering av tiltak er basert på om det finnes vitenskapelige studier som undersøker empirisk hvorvidt tiltak fører til reduksjoner i ulykker, usikkerhet og relevans (dvs. femte mål). Vår vurdering er farget av dette og konservativ, i den forstand at vi har en tendens til å rangere eksisterende og «eldre» tiltak høyere. Årsaken er at det er mer forskning på eldre tiltak, og dermed mer informasjon om effekter på ulykker, mindre usikkerhet, mer velutviklet og brukervennlig teknologi etc. Vi forsøker å kompensere for denne skjevheten ved også å fremheve tiltak som virker lovende, men som det er lite relevant forskning på, noe som indikerer behov for fremtidig forskning.

Anbefalinger

Mange av tiltakene som vi vurderer er allerede juridisk påkrevde i busstransport og implementeres dermed i bedrifter. Vi vurderer dem likevel, for å gi en oversikt over effektivitet og relevans. Mange av tiltakene som allerede kreves får høy poengsum i vår vurdering. Det er imidlertid mest relevant å gi anbefalinger basert på effektive og relevante tiltak som ikke er lovpålagt (ennå), og som dermed ikke er fullt ut implementert. Dette er tiltak som noen busselskap har, men ikke alle, siden tiltakene ikke er obligatoriske. På bakgrunn av det anbefaler vi at følgende tiltak gjøres obligatoriske i busstransport: 1) Flåtestyringssystemer for å legge til rette for myk kjørestil, 2) Sikkerhetskulturtiltak, 3) Sikkerhetsstyringssystemer, 4) Kollisjonssikring for bussjåførere. Disse tiltakene er ikke lovpålagt i busstransport, selv om de er svært effektive for å forebygge ulykker. Sikkerhetskulturtiltak og sikkerhetsstyringssystemer kreves i andre transportsektorer, med høyt sikkerhetsnivå (f.eks. luftfart, jernbane, maritim sektor). Tiltak 1-3 bør kreves av administrasjonsselskapene for kollektivtrafikk og andre som kjøper busstransport gjennom kontrakter med bussoperatører. Når det gjelder tiltak 4 anbefaler vi en egen europeisk standard for kollisjonssikkerhet i buss (i stedet for dagens situasjon, som innebærer at buss er omfattet av regelverket for andre typer kjøretøy).

Andre tiltak er allerede påkrevd, men ikke fullt ut implementert i praksis. Gitt deres effektivitet, er det relevant å finne tiltak som tar sikte på å øke implementeringen. Dette gjelder f.eks. tiltak for å øke bilbeltebruken blant passasjerer i klasse 3 og 2 busser. Dette kan gjøres av både nasjonale myndigheter og administrasjonsselskapene for kollektivtrafikk og andre som kjøper busstransport.

I tillegg er det også flere tiltak som virker lovende, men som det er lite relevant forskning på, eller de nåværende versjonene av teknologien er kanskje ikke fullt utviklet ennå. Dette gjelder f.eks. geofence fartsbegrensere, varslingssystemer for myke trafikanter og nødbrems, overkjøringshinder og kollisjonsputer for fotgjengere, tiltak for å hindre fallulykker om bord i busser, tiltak for å sikre rullestoler og barnevogner. Disse temaene indikerer behov for videre forskning. Disse tiltakene må videreutvikles og undersøkes av en rekke sentrale interessenter innen busstransport.

1 Introduction

1.1 Background

Travel by public transport – bus, train or tram – is very safe and perceived to be so (Elvik and Bjørnskau, 2005). Estimates for Norway for 1998–2002 indicated 0.93 fatalities in road crashes per billion passenger km for bus, versus 3.82 fatalities per billion km for car occupants (driver and passenger). Being a large vehicle, a bus protects its occupants well. Hence, most injuries in collisions where buses are involved are sustained by other road users.

In recent years, several bus drivers have, however, been involved in serious accidents on Norwegian roads, under conditions which should not indicate serious outcomes. Since 2011, eight bus drivers have been killed and five severely injured in head-on collisions (Norwegian Public Roads Administration, 2021). These accidents deserve attention, as several of them have occurred under conditions which should not indicate fatal outcomes for the bus drivers (e.g., a speed of 30Km/h). The key explanation for these serious outcomes in low-speed accidents is lacking legal requirements to physical collision protection in the front of the bus, and thus that several buses provide insufficient physical protection for drivers in accidents. Based on this, the safety of bus drivers has come on the agenda in Norway. Driver unions, employer organisations, transit authorities etc. have raised this issue, and on October 1. 2023, Norwegian authorities implement new rules requiring physical collision protection for bus drivers.

Additionally, recent reports indicate that large numbers of passengers are injured in incidents onboard buses (Nævestad et al 2020). An overview of traffic incidents reported to Norway's largest transit authority in the period 2016-2020 indicates that the incident type that involved the highest level of personal injuries in bus transport was onboard injuries among passengers, presumably related to abrupt braking and acceleration, and injuries related to going on/of the bus. This result is in accordance with previous research (Kendrick et al 2015; Elvik 2019). Elvik (2019) suggests that travel by bus may not be as safe as the low risk of injury to bus passengers in road collisions suggests, as several studies have found that there are many non-collision injuries to bus passengers. A non-collision injury is any injury not sustained in a road collision, but due to other events, i.e. onboard injury due to abrupt braking/acceleration (particularly among standing passengers) and while going on/off. Elvik (2019) concludes that these incidents are not recorded, nor their contributing factors, and thus knowledge is lacking on how to prevent these injuries. Moreover, he also estimates that the mean risk of falling in a moving bus is about 0.3–0.5 per million passenger kilometres, while the mean risk of injury associated with going on/of is about 0.8–1.7 per million passengers.

A final theme indicating the importance of safety in bus transport is that there is a societal shift to both increased bus transport in cities as well as an increase in vulnerable transport modes, e.g., walking, cycling, e-scooters etc. which might lead to an increase in conflicts between buses and vulnerable road users in cities. Bentama et al (2017) analyses 2,338 accidents with buses in France, between 2012-2014, and find that these lead to 1,382 injured bus passengers and 2,081 injured third parties, i.e., road users outside the bus. Among the latter, 38% were car drivers, 38% pedestrians and 16% motorized two-wheelers. It is likely that increase in bus transport and walking, cycling, e-scooters etc. might increase the number of accidents involving buses and vulnerable road users. These three issues indicate the importance of safety in bus transport.

1.2 Aims

The study seeks to develop an overview on the current status and potential measures for improving driver and traffic safety in buses. The report will provide decision-makers and procurers with a foundation for setting effective and relevant requirements for enhanced traffic safety. The aims of the study are to provide:

- 1) An overview of the traffic safety situation and historical accident statistics for bus transport in Norway and Europe
- 2) Description of the necessary safety management systems and safety culture features required to improve traffic safety in bus transport
- 3) Overview of measures to reduce the occurrence of accidents, including estimated effectiveness of these measures where possible
- 4) Overview of potential measures to reduce the consequences of accidents, including estimated effectiveness of these measures where possible
- 5) Rating of the measures, based on whether they lead to reductions in accidents, uncertainty and relevance.

2 Method

2.1 Status of traffic safety in bus transport

2.1.1 Accidents, exposure, and risk

The number of bus drivers and bus passengers who were injured during 1990-2022 was taken from official Norwegian accident statistics. Injuries were classified as fatal, serious, or slight. There were too few fatal injuries to support meaningful estimates of risk. For fatal and serious injuries combined, and for all injuries (fatal, serious, slight) risk estimates were developed by dividing the number of injured bus drivers or bus passengers with exposure. Exposure for bus drivers was taken to be identical to vehicle kilometers performed by buses. Exposure for bus passengers was stated as million passenger kilometers of travel. Estimates of bus and passenger kilometers were taken from the annual report on transport statistics for Norway, published by the Institute of Transport Economics (Flotve & Farstad, 2022). Estimates of risk of injury to car drivers was taken from a report by Bjørnskau (2020). Bus drivers have slightly lower risk of injury than car drivers. However, injuries are underreported in official accident statistics.

We also present European statistics on bus accidents based on the report “European Road Safety Observatory Facts and Figures – Buses / coaches / heavy goods vehicles – 2021” The main data source for this report is CARE (Community database on Accidents on the Roads in Europe). The database contains data obtained from national data sources, not only EU members but also from the UK and the 4 EFTA countries (Switzerland, Norway, Iceland, and Liechtenstein). The data in the report were extracted on 12 April 2021. As the database is not complete for all countries and all years, additional data were provided by the European Commission in order to be able to calculate the general total for fatalities for the EU27.

2.1.2 Incidents reported to the largest transit authority in Norway

These were originally described in Nævestad et al (2020), based on 797 reported bus incidents and accidents. The incidents occurred in October 2016 to February 2020. The incidents were reported to the largest transit authority in Norway, which is Ruter, by passengers, other road users, emergency services etc. The incidents were originally described in free text in a spreadsheet of reported incidents, which also indicates the time and date of the incidents. Nævestad et al (2020) read through all 797 events and created 15 incident codes. The incident codes are based on a qualitative interpretation of the incidents. See Nævestad et al (2020) for information on the coding of incident types and degree of damage in the incidents and accidents.

2.2 Literature review

We carried out a literature review of various traffic safety measures in bus transport. The main aim of the review is to summarize available knowledge about the safety effects of such measures. Many measures have mostly been studied in the context of light vehicles or trucks; in these cases, we discussed whether the knowledge is also valid for buses.

Literature review was mainly conducted by Google Scholar, with the respective measures as search terms, in addition to a safety-related search term (“safety”, “accident”, “crash”, or “injury”) and “bus” or “coach”. When we did not find any relevant studies, we tried alternative terms that describe the measure or omitted “bus”/“coach” from the search.

2.2.1 Assessment of measures

We have assessed the relevance of each measure for bus safety in the current Norwegian context (Aim 1). The knowledge about each measure is summarized in six points in the form of a table in the following format (Table 2.1).

Table 2.1: Qualitative and quantitative criteria for assessment of measures in the literature review.

	Measure studied on buses?	Does the measure reduce accidents / injuries?	Target group of road users	How uncertain is the effect?	Is the measure in conflict with other measures?	Is the measure relevant?
Qualitative assessment	Yes / No	Yes, a reduction of A-B percent / No	Persons within bus / Other road users	High / Medium / Low	Yes, in which case which measures / No	Yes / No / Maybe
Quantitative assessment	0: No / 1: No, but in other relevant cases / 2: Yes	0: No / 1: Yes, most likely / 2: Yes, small effect / 3: Yes, large effect	Driver / Vulnerable road users / Other Road users / Passengers / All	1: High / 2: Medium / 3: Low	-1: Yes / 0: No / +1: No, and other benefits (e.g., reduced omissions)	0: No / 1: Yes, maybe / 2: Yes, to some extent / 3: Yes, to a large extent

For all measures, we assigned points based on the criteria presented in Table 2.1, and calculate a total score for each measure. Assessing the measures, we primarily focus on the measures' potential effect on accidents, the quality of the studies and whether they are relevant for buses. We also address what road user groups that benefit the most in terms of reductions in accidents or injuries, and whether the measure conflicts with other goals, based on results from the evaluated studies. We also include studies that address measures that have been studied in the context of heavy goods vehicles and passenger cars, if we find it relevant, and/or if there are no studies from bus transport.

The research literature we draw on has primarily been identified through previous literature searches in connection with The Handbook of Road Safety Measures (<https://tsh.toi.no>). The Handbook of Road Safety Measures provides an overview of current knowledge about the effects of 142 traffic safety measures. The main focus of the handbook is to determine how effective the measures are in reducing accidents or injuries caused by accidents. The accident studies on which the book is based are, as far as possible, summarized using meta-analysis. The Handbook of Road Safety Measures is continuously updated with current research findings. We also draw on (and update) other relevant literature searches, for example from Nævestad et al., (2018a,b) and Høyve et al., (2022).

2.3 Interviews

We have conducted qualitative research interviews and informal discussions with procurers of public transport in Norway, to obtain information about the state of the art within bus safety measures. The measures that we get information about through literature review are generally slightly older, as it takes time to conduct research and report the results. The interviews and discussions have been conducted with key actors within bus transport procurement, with good knowledge of state of the art. Thus, the purpose of the interviews was to compensate for the time-lag in the literature review. We have also used web searches for this purpose, to get an update on existing and upcoming measures. The interview guide was structured according to the classification of measures that we use in the present report: organisational measures, measures addressing onboard passenger safety, crashworthiness and driver protection, crash protection for vulnerable road users, driver assistance systems – mandatory systems, driver assistance systems – optional systems and other measures. In the interviews, we discussed status for each of the thirty-three specific measures reviewed. We also obtained information about the types of measures required by procurers of bus transport in Norway,

including variation among them when it comes to requiring e.g., more than what is required by the law.

3 Overview of the traffic safety situation

This section focuses on the first aim of the study, which is to provide an overview of the traffic safety situation and historical accident statistics for bus transport in Europe.

3.1 Accidents with buses in Europe

Development over time. During the decade 2010-2019, there has been substantial reduction in the number of fatalities in bus and coach accidents in Europe. Between reference years 2010 and 2019, the number of fatalities in crashes involving buses/coaches have decreased by 34%.

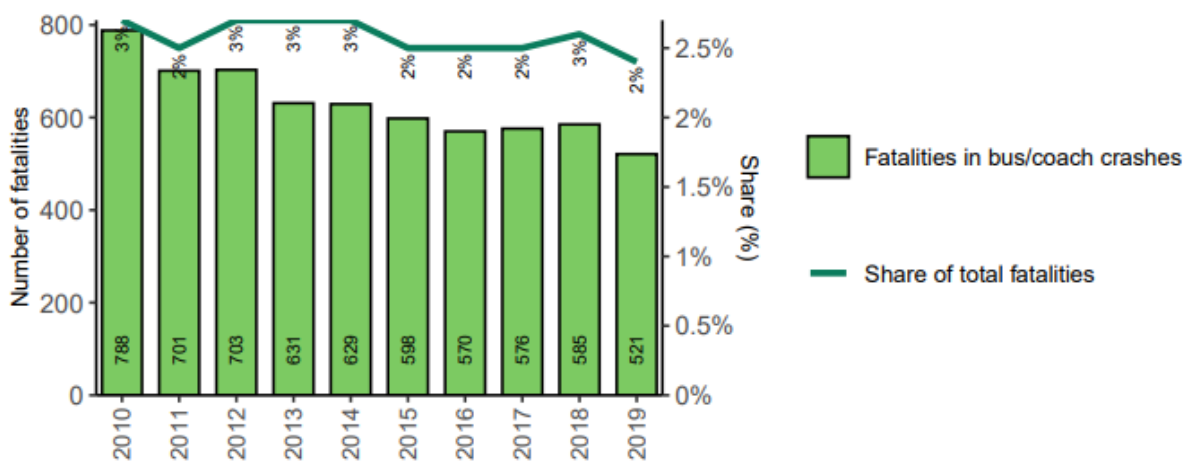

Figure 3.1: Annual number of fatalities in bus/coach crashes, and their share in the total number of fatalities in the EU27. (2010-2019). Source: CARE). Source of data: CARE. Source of Figure: “European Road Safety Observatory Facts and Figures – Buses / coaches / heavy goods vehicles – 2021” https://road-safety.transport.ec.europa.eu/system/files/2022-03/FF_buses_hgv_20220209.pdf

These types of crashes represent 2% of the total number of road fatalities. In comparison, accidents involving heavy goods vehicles represent 14% of the total number of fatal accidents in EU.

Demographic characteristics of people killed. A share of 77% of all road fatalities in the EU involve men. In bus and coach crashes, the percentage of men is 64%. Looking at age groups, the share of persons over 50 is higher in bus/coach crashes than among all fatalities.

Type of road users killed. In bus/coach crashes, 21% of the fatalities involve the occupants of the bus/coach itself. This is different from fatal car crashes where 60% of the fatalities are among the occupants of these vehicles themselves. Among those killed in bus/coach crashes, there is a high proportion of vulnerable road users (37%). Especially the proportion of pedestrians is very high (29%) which is related to the urban environment in which many buses operate.

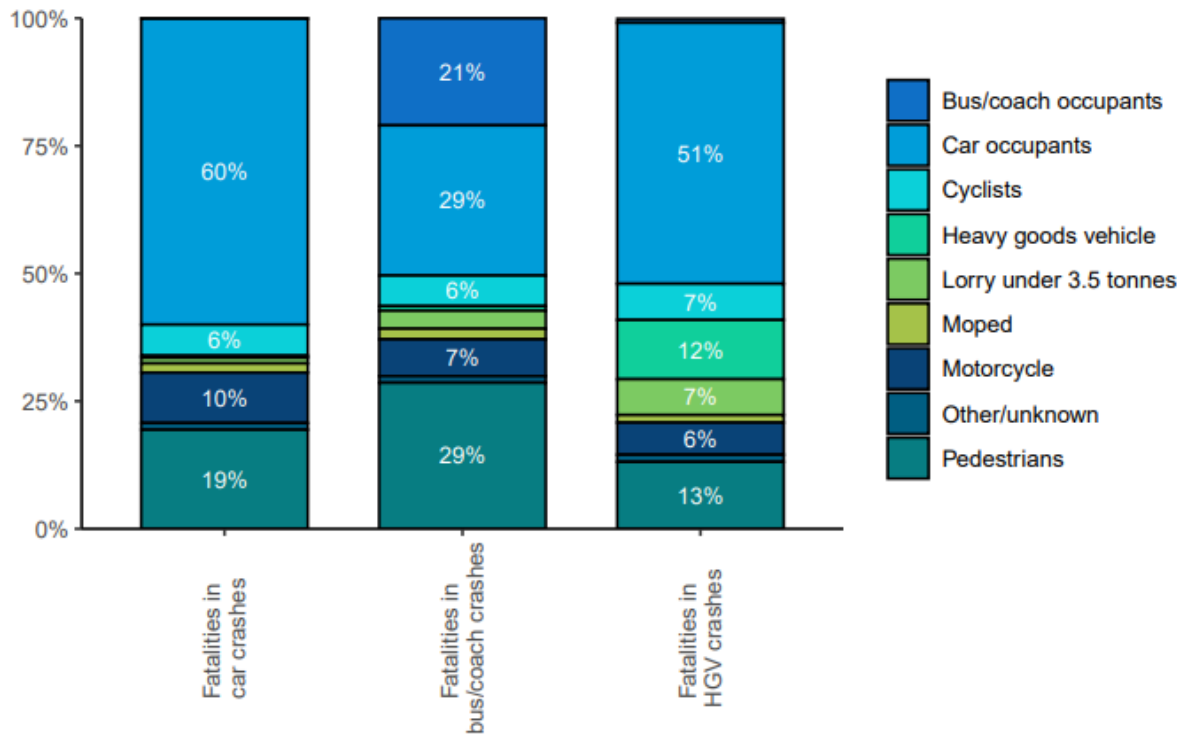

Figure 3.2: Distribution of fatalities by transport mode in HGV crashes, bus/coach crashes, and car crashes in the EU27 (2019). Source of data: CARE. Source of Figure: “European Road Safety Observatory Facts and Figures – Buses / coaches / heavy goods vehicles – 2021” https://road-safety.transport.ec.europa.eu/system/files/2022-03/FF_buses_hgv_20220209.pdf

Road types and characteristics. When it comes to the road types that bus accidents occur on in Europe there is an almost equal proportion of fatalities in bus/coach crashes on urban and rural roads (resp. 49% and 42% in 2018). The share of fatal bus accidents on motorways is relatively small, at 9% in 2018. The vast majority of road fatalities occur on road stretches and not at junctions or roundabouts. The relative share of all fatalities on road stretches was 72% in the case of fatalities in bus/coach crashes.

3.2 Accident risk in bus transport in Norway

3.2.1 Under reporting

Injuries are underreported in official accident statistics. Estimates of the real number of injured road users are based on a report by Lund (2019). This report contains estimates for the year 2017. Figure 3.3 shows reported and estimated number of injured road users, by road user group, for 2017.

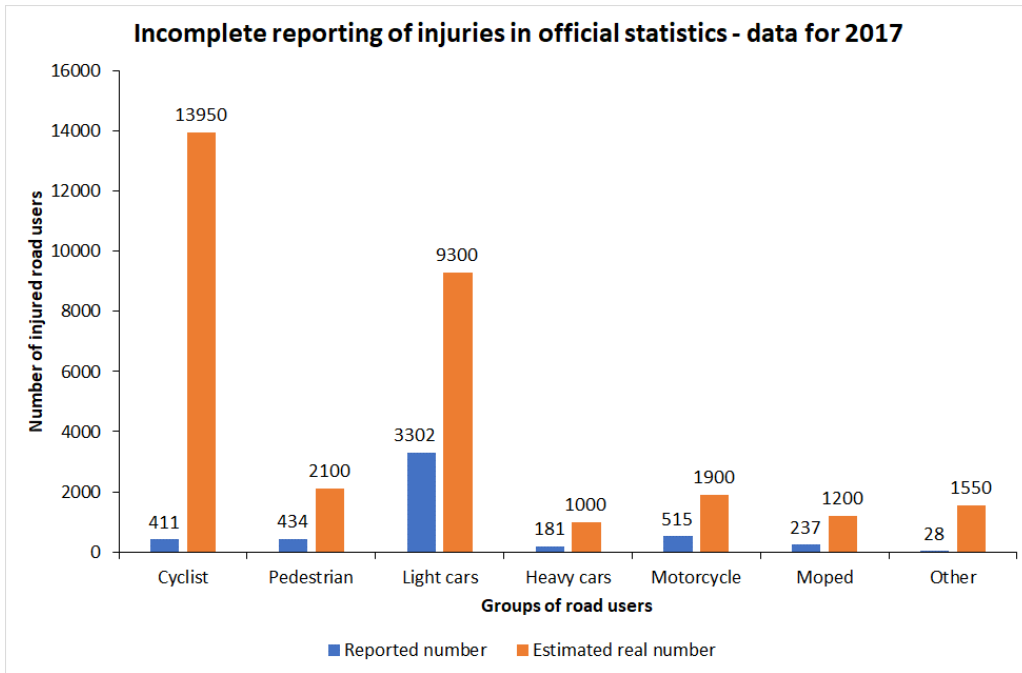

Figure 3.3: Reported and estimated real number of injured road users in Norway by road user group for 2017

Unfortunately, buses are not listed separately, but are included in the group heavy vehicles. However, there are on average far more occupants in a bus than in a truck. Hence, underreporting is likely to be greater for buses than for trucks. The estimated risk of injury to bus passengers in traffic accidents, based on official accident statistics, is about 0.007 in recent years. Corrected for underreporting an estimate of 0.05 for the real risk of injury is proposed.

3.2.2 Trends for bus drivers

Figure 3.4 shows changes in the risk of fatal or serious injury to bus drivers from 1990 to 2022. Risk has been estimated on the basis of official accident statistics, which, as noted above, has incomplete reporting of injuries. However, unless reporting has become much less complete over time, the declining trend seen in Figure 3.4 is probably real.



Figure 3.4: Risk of fatal or serious injury to bus drivers

The risk of fatal or serious injury to bus drivers has declined from 1990 to 2022. It is, however, not possible to fit a meaningful trend line to the data. There has been zero fatal or serious injuries in some of the recent years, for example 2015, 2018 and 2019.

Figure 3.5 shows the development of the risk of any injury to bus drivers from 1990 to 2022.

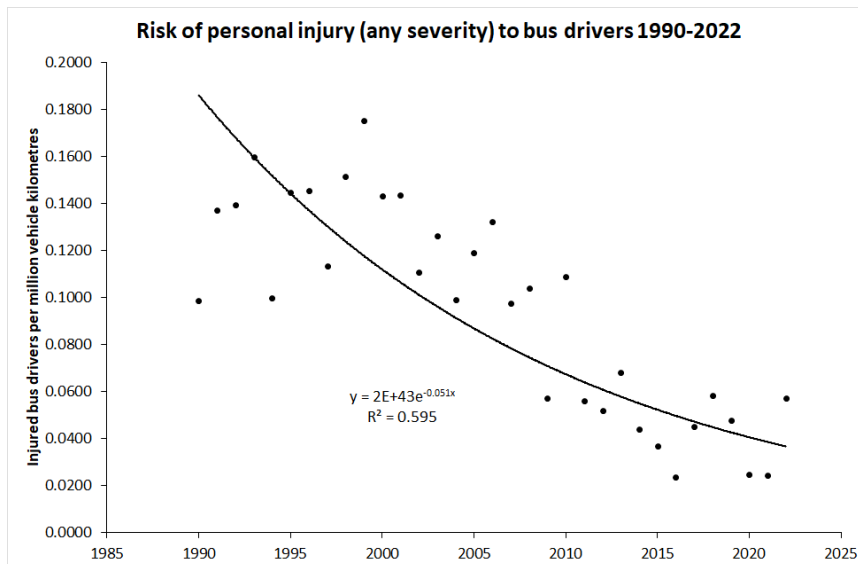

Figure 3.5: Risk of injury (any severity) to bus drivers 1990-2022

Risk has declined by about 5.1 % per year, but there is considerable variation around the trend line and there have been periods of increasing risk lasting for more than two years.

3.2.3 Trends for bus passengers

Figure 3.6 shows the risk of fatal or serious injury to bus passengers 1990-2022.



Figure 3.6: Risk of fatal or serious injury to bus passengers 1990-2022

Figure 3.6 shows changes in the risk of fatal or serious injury to bus passengers from 1990 to 2022. There is a declining trend, but it is not possible to summarise this trend by means of a trend line. There were zero fatal or serious injuries in 2017 and 2020.

Figure 3.7 shows the risk of any personal injury to bus passengers during 1990-2022.

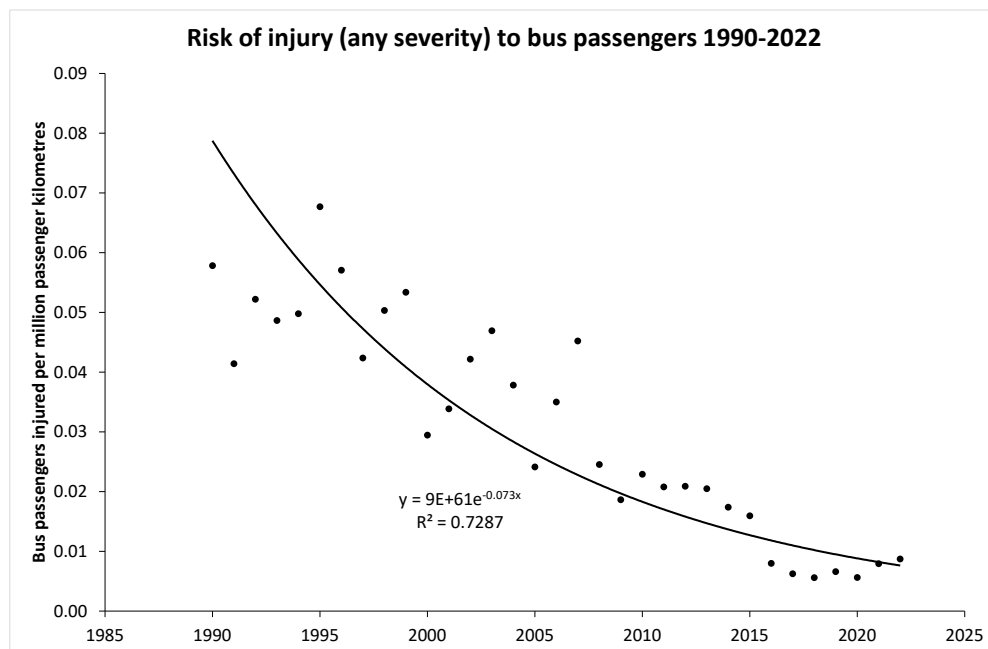

Figure 3.7: Risk of injury (any severity) to bus passengers 1990-2022

There is very clear declining trend in the risk of injury, indicating an average reduction of 7.3 % per year. It should be noted, however, that risk has not declined after 2015 and shows a slight increase in 2021 and 2022.

3.2.4 Comparison of risk for bus drivers and car drivers

Figure 3.8 compares the risk of injury to bus drivers to the risk of injury to car drivers. Bus drivers have a slightly lower risk of injury than car drivers. It is, however, not known if the reporting of injuries is equally incomplete for bus drivers and car drivers. Since bus drivers are professional drivers employed by a bus company, it seems reasonable to assume that the reporting of injuries might be more complete than for car drivers. In that case, the comparison in Figure 3.8 is perhaps somewhat misleading, in that the true difference in risk could be greater, in the favour of bus drivers.

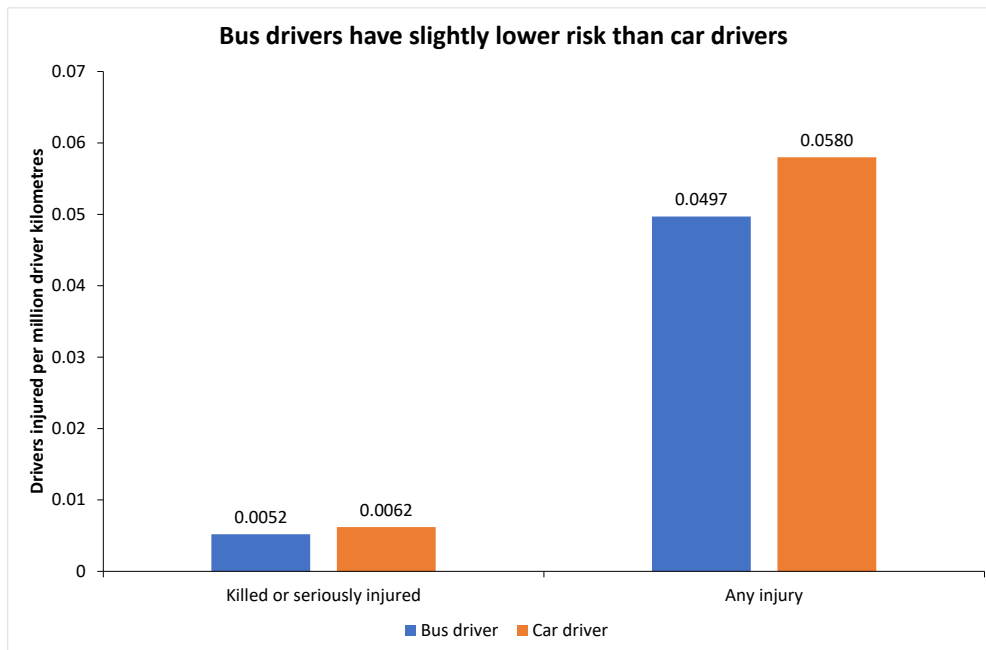

Figure 3.8: Risk of injury to bus drivers compared to car drivers

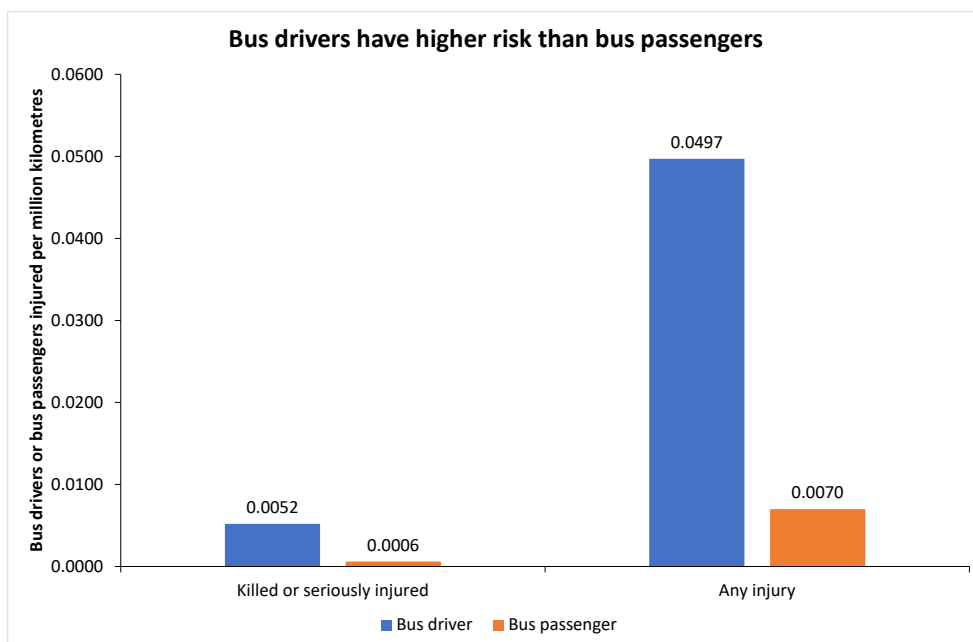

Figure 3.9: Risk of injury to bus drivers compared to bus passengers

Figure 3.9 compares the risk of injury to bus drivers with the risk of injury to bus passengers. Bus passengers have considerably lower risk of injury than bus drivers. The estimates are based on data for the most recent years (2017-2022).

Figure 3.10 shows the total risk of injury to bus passengers. During the period from December 2021 to December 2022, Norway's largest transit authority Ruter recorded 188 cases of personal injury in incidents not classified as traffic accidents. These include falls on board and fall when going on/off buses. In 2022, passenger kilometres performed by buses in the Ruter system was 759 million passenger kilometres. Thus, the risk of injury in non-collision events was $188/759 = 0.248$, which can be rounded to 0.25. Hence, the risk of injury to bus passengers is 0.007 based on official statistics,

0.05 when corrected for underreporting and 0.30 (0.05 + 0.25) when injuries not sustained in traffic accidents are also included.

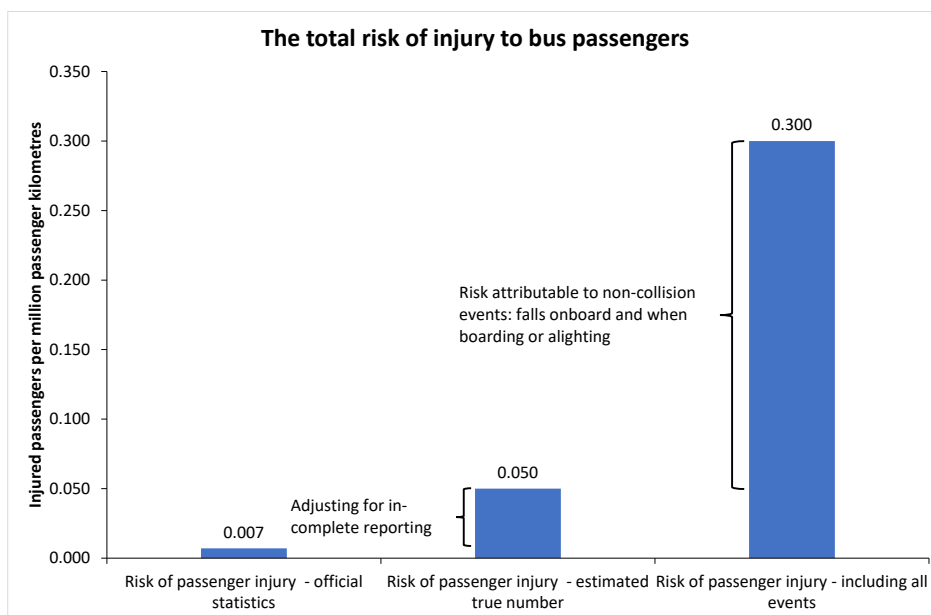

Figure 3.10: Total risk of injury to bus passengers

Figure 3.10 shows the total risk of injury to bus passengers per million passenger kilometres. According to official accident statistics, the risk is 0.007. Adjusted for incomplete reporting, risk is 0.050. To this should be added injuries in non-collision events, with a risk of 0.25 per million passenger kilometres. Total risk then becomes 0.30 per million passenger kilometres. It is noteworthy that most of this risk is not attributable to reportable traffic accidents, but other injury events, not defined as traffic accidents.

3.3 Incidents reported to Norway’s largest transit authority

Analyzes of approximately 800 reported incidents from October 2016 to February 2020 show that "Traffic accident collision" (N = 360) is the type of incident that has been most prevalent during the period, followed by "passengers injured on board" (N = 98).

Table 3.1: Reported accidents and incidents involving buses that have driven for Ruter in Oslo and Viken in the period October 2016 to February 2020 (Source: Nævestad et al 2020)

Incident type	Personal injury			Total
	Yes	No	Unclear	
Traffic accident - collision	40	299	21	360
Onboard injury - passenger	61	9	28	98
Traffic accident - no counterpart	3	89	0	92
Disembarkation - boarding - passenger	13	5	16	34
Traffic accident - pedestrian	19	4	11	34
Externally	7	11	16	34
Unclear	6	8	14	28
Aggressiveness	4	5	14	23
Disease	17	2	2	21
Non conformity	0	17	3	20
Traffic accident - cyclist	10	3	5	18
Other	3	11	4	18
Disturbing person	0	6	2	8
Traffic accident - motorcycle	1	2	2	5
Near accident		4		4
Total	184	471	138	797

The fact that collisions are the most prevalent type of incident during the period does not necessarily mean that it is this type of incident that has involved the most personal injuries. In Figure 3.11, we show the types of incidents that involved the most personal injuries in the period. We show absolute numbers.

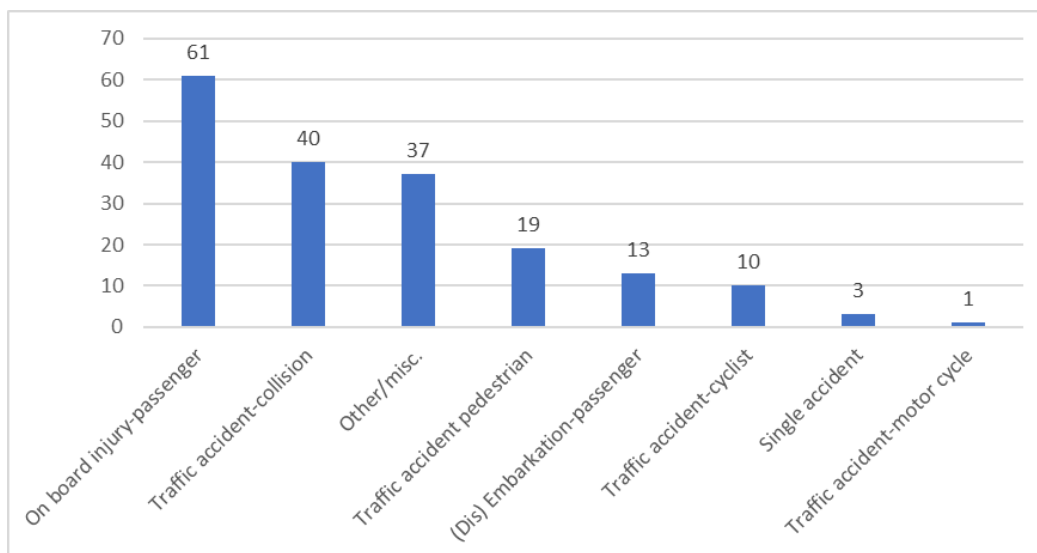

Figure 3.11: The reported types of incidents that involved the most personal injuries, by occurrence. Buses driven for Ruter from October 2016 to February 2020.

On-board passenger injuries are the type of incident that has involved the most personal injuries. However, the number of personal injuries related to an incident does not necessarily say anything about how often a certain type of incident leads to personal injury. This is the reason why we also analyze the share of personal injuries in the reported types of incidents. The following types of incidents have the highest share of injuries: on-board injury- passengers, traffic accidents involving

pedestrians, traffic accidents involving cyclists and incidents involving boarding of passengers. This indicates a lower level of protection for the persons involved in these incidents.

The result may indicate that the traffic safety potential associated with measures aimed at preventing the occurrence of these incidents and their severity may be significant. Our results are in line with previous research, which also shows that injuries that do not occur in traffic accidents are a major problem in buses, i.e., injuries when falling on board the bus or falling when getting on or off (Kendrick et al 2015; Elvik 2019).

4 Organizational measures

4.1 Safety management systems

Safety management systems consist of formal procedures and measures that enable organizations to work systematically with safety, such as identifying risks through formal risk analyses, developing, and implementing corrective measures (e.g., procedures, training), defining roles and responsibilities, regularly monitoring status, tracking various safety indicators (KPIs), and implementing corrective measures if necessary (Thomas, 2012).

4.1.1 Results from previous research

In their literature review of the effects of various traffic safety measures targeting drivers at work in general, and heavy goods vehicles, in particular Nævestad et al. (2018a) found that there is generally less focus on safety culture and safety management in the road sector compared to other transport sectors. This is explained by the fact that road sector companies do not have the same legal requirements for safety management systems as in aviation (IATA, 2019), maritime sector (Lappalainen et al., 2014), and railways (ERA 2023). These sectors have requirements for systems that address various aspects of safety culture, such as reporting procedures, just culture, and learning. These requirements are often cited to explain why aviation, maritime, and rail transport generally have a high level of safety culture and low accident risk (Hudson, 2003; Lappalainen et al., 2014; Amtrak, 2015).

This is in contrast to the road sector, where safety management systems are voluntary. This applies, for example, to the voluntary ISO 39001 standard, which is often described as a management system for traffic safety and a tool for building a safety culture. An explicit goal of this standard is to create a positive safety culture by implementing a safety management system with specific procedures, etc. Among the basic elements of the standard are mapping of users, stakeholders, and their needs, as well as mapping of the organization's tasks and employees' roles, responsibilities, and authority. The standard promotes systematic safety work by requiring planning, implementation, and evaluation of processes (Naveh & Katz-Navon, 2015).

We have identified a total of 8 studies focusing on safety management systems. Three of the studies focus solely on safety structure, while five focus on both safety culture and structure. These results are also relevant to buses (e.g., Naveh & Katz-Navon, 2015).

Three of the studies primarily focus on safety management systems. In his systematic review of the effects of safety management systems in the transport sector, Thomas (2012) concludes that, despite limited research in the field, there seems to be a relationship between safety management systems and objective safety outcomes (behavior, accidents). Although there is no agreement on which components of safety management systems contribute the most to safety, Thomas (2012) concludes that the following two factors are the most important: management commitment to safety and safety communication. The methodologically robust study by Naveh and Marcus (2007) supports the conclusion that safety management systems enhance safety, although it is a study of a quality management system (ISO 9000) focusing on systematic documentation and compliance between procedures and practices. Naveh and Marcus (2007) compare 40 ISO 9002-certified heavy vehicle companies with 40 matched control groups and find that certified companies showed significant improvements in safety (28/40) compared to matched controls (18/40) over a two-year period after certification. Risk analysis is another key component of safety management systems. In a study of insurance requirements in heavy transport companies, Mooren et al. (2014b) find that companies with the lowest insurance payouts appear to focus more on proactive risk analyses.

In addition, we have identified five studies focusing on both safety culture and safety management systems. Murray et al. (2012) and Murray et al. (2009) are case studies describing comprehensive packages of safety management measures in companies. These studies find up to a 55% reduction in accident costs and nearly a halving of non-fault accidents. The two studies by Murray et al. (2009; 2012) are inspiring, but they lack details about the specific measures, and often multiple measures have been implemented simultaneously, making it difficult to determine exactly which measures have had an effect. This makes it challenging to link measures and effects, thus making it difficult for others to learn from the studied measures. Additionally, these studies do not necessarily control for external factors, such as a general decrease in traffic accidents during the studied periods. The same conclusions regarding uncertainty about effects apply to Wallington et al. (2014), who studied a comprehensive program at British Telecom involving 95,000 workers from 2001 to 2012. The study shows a significant and substantial reduction in accidents and insurance costs, which are linked to training measures, risk analysis, and other measures that can be categorized as safety management systems. Mooren et al. (2014a) conducted a literature review of research literature on safety management. The authors evaluated studies from other sectors for their relevance to heavy road transport and the potential to use insights to reduce accidents involving heavy vehicles. They found that safety training is one of three management practices robustly related to safety outcomes in three different study designs. Naveh and Katz-Navon (2015) studied an intervention involving the implementation of ISO 39001 combined with other measures to promote a good safety culture (increased management engagement and internal safety campaigns). The study found that the intervention is associated with improved safety climate and improved safety behavior among drivers. The study also included four bus companies. The work with ISO 39001 in the studied companies included, among other things, risk analysis based on collected data on incidents, statistical analyses, and the implementation of relevant measures to prevent the identified categories of incidents.

All the evaluated studies find that the implementation of safety management systems increases safety. However, it should be noted that this field might be influenced by publication bias (i.e., that studies with non-significant results are not published). Moreover, the quality of the studies varies, and it is difficult to identify precisely which elements of safety management systems have a positive effect on safety. Safety management systems are generally a type of measure that is challenging to evaluate because they consist of many different components and can be implemented in various ways. In essence, safety management systems comprise a set of formal procedures and measures, but these can be introduced in companies without being followed or adhered to in practice. This discrepancy between formal and informal aspects of safety is illustrated in various accident studies, which reveal that individuals "do something different from what they say they will do in the systems." The informal aspects of safety, or "what people actually do," are related to safety culture. For safety management systems to be effective, they must be combined with or used as a tool to create a good safety culture (Nævestad et al., 2018b). This is the stated goal of safety management systems in aviation, maritime, and railway industries (Hudson, 2003; Lappalainen et al., 2014; Amtrak, 2015), as well as ISO 39001. It can be assumed that this measure will result in fewer accidents and injuries because it is a common way to introduce a safety culture, and a good safety culture is associated with fewer injuries and accidents (Bjørnskau & Nævestad, 2013; Nævestad et al., 2018). Regarding specific elements, it appears that leadership focus on safety, safety communication, and risk analysis.

This measure is relevant to the traffic safety situation because risk analysis, monitoring of key indicators, analysis of incidents and causes (learning) can provide an overview of accidents and injuries, as well as relevant measures (cf. Naveh and Katz-Navon, 2015). This measure is more challenging to evaluate because it is a meta-measure or an approach to (or systematization of) safety work that can be implemented in various ways.

4.1.2 Relevance

Based on the literature review, we conclude that this measure probably reduces accidents or injuries, but its effectiveness depends on implementation. Safety management systems are a common way to introduce a safety culture. However, introducing a good safety culture is not necessarily a type of intervention that automatically leads to the desired outcome. We conclude that the uncertainty associated with the effects of the measure is medium, as it is difficult to pinpoint which elements are most important. However, leadership focus on safety, safety communication, and risk analysis appears to be key elements. Based on the accident analysis, we cannot draw a conclusion about the relevance of this measure. This is relevant to the traffic safety situation because such routines can provide an overview of the specific injury patterns that individual bus operators deal with, and they can also represent a systematic way to identify relevant measures.

Table 4.1: Assessment of effects of safety management systems.

	Measure studied on buses?	Does the measure reduce accidents / injuries?	Target group of road users	How uncertain is the effect?	Is the measure in conflict with other measures?	Is the measure relevant?
	Yes, probably	Likely reduction, but implementation-dependent	Bus passengers and other road users	Medium to high. Difficult to pinpoint the most important elements	Uncertain, probably not	Yes, risk analysis and learning can provide an overview of accidents and relevant measures
8	1	2		2	0	3

4.2 Measures to improve safety culture

4.2.1 Results from previous research

Previous research shows, as mentioned, that there is generally less focus on safety culture and safety management in the road sector compared to other transport sectors (see Nævestad, 2018a), likely because there are no legal requirements for safety management systems in the road sector. Existing studies, both from the road sector and other transport sectors, demonstrate clear relationships between safety culture and accident risk (Naveh and Katz Navon 2015; Bjørnskau and Nævestad 2013). However, it should be noted that there are very few studies of sufficiently high quality to provide reliable estimates of the effects on accidents, and the interventions studied often consist of multiple different measures, making it difficult to pinpoint the effects of specific measures.

Nævestad et al. (2018a) identified 20 studies describing the content and effects of interventions aimed at influencing safety culture in transport organizations in general. Of these, eight studies were from road transport, five from air transport, three from maritime transport, and four from rail transport. All studies from the road sector show positive results of the interventions studied. However, few of the studies are based on robust designs, i.e., pre- and post-measurements with relevant control groups. Two of the studies also have small sample sizes (e.g., Newnam & Oxley, 2016; Goette et al., 2015). The studies with the highest quality are the study by Gregersen et al. (1996) and the study by Naveh and Katz Navon (2015). The study by Gregersen et al. (1996), which has a robust design (pre-post measurement and control group), finds a 59% reduction in accident risk.

The safety culture interventions in the road sector vary greatly in terms of the resources they require. On one hand, there are relatively simple interventions (group discussions, training, or

company campaigns) aimed at improving driver safety (Gregersen et al., 1996; Salminen, 2008). On the other hand, there are more comprehensive and long-term interventions that consist of a range of different measures combined over time (Murray, White & Ison, 2012; Murray, Ison, Gallemore & Nijar, 2009; Wallington et al., 2014).

Given that both relatively simple and highly comprehensive measures can have a similar effect on accidents, it seems reasonable to conclude that simple measures such as driver-led group discussions (Gregersen et al., 1996) are more cost-effective than extensive programs, and that these can be a good alternative for smaller transport companies with limited resources. Salminen (2008) identifies two main strengths of the group discussion method: (i) it increases employee ownership of the process by encouraging employees to work together to propose and implement solutions to traffic safety problems, and (ii) it harnesses the mechanism of "group pressure" in a way that can contribute to safer behavior in traffic.

The diversity of measures available to improve safety culture in road sector companies is extensive. This means that the definition of what constitutes a measure to improve safety culture is broad; it can be many things, such as implementing a safety management system, conducting an attitude campaign within the company, or facilitating group discussions, and so on. In addition, typical safety interventions in companies often consist of multiple measures in combination, making it difficult to assess the isolated effects of measures. However, we observe that virtually all measures evaluated by Nævestad et al. (2018a) have an effect, even though they initially appear to be different. Therefore, it is relevant to attempt to define common underlying elements in the interventions and factors that influence their effect. This can also make it less resource-intensive and thus more realistic for organizations to implement such measures.

The most important element in all interventions is to increase risk awareness among managers and employees through shared discussions about hazards in the work environment. This process typically involves four key activities:

1. Appointing a key person (usually a leader) to be responsible for implementing the intervention.
2. Institutionalizing shared discussions and risk assessments of hazards in the work environment involving both leaders and employees.
3. Implementing and continuously following up on measures based on these discussions and shared risk assessments, such as reporting systems and training.
4. Ensuring effective communication about safety issues within the organization, following the principles of an informed safety culture outlined by Reason (1997).

The most important element in all interventions seems to be increasing risk awareness through shared discussions about hazards in the work environment between leaders and employees. This approach underlies many of the evaluated interventions. Developing an informed culture (Reason, 1997) means increasing the organization's ability to identify and correct hazards at both the system level and the "sharp end" to create a safer workplace.

Since safety culture interventions can be abstract, we believe that the most concrete way to implement them is by conducting the four key activities mentioned above. When done in a formalized manner—meaning defining organizational roles with responsibilities, formal procedures describing key activities, etc.—it would essentially entail implementing a safety management system (see section 4.1).

However, research on culture in organizations also emphasizes that culture changes through daily leadership, not just through time-limited interventions. According to influential researcher Edgar Schein (2004: 246), leadership and culture are two sides of the same coin. Schein outlines what he calls "six primary embedding mechanisms" that leaders can use to shape culture:

1. What leaders pay attention to, measure, and control regularly
2. How leaders respond to critical events and organizational crises
3. How leaders allocate resources
4. Conscious role modeling, teaching, and coaching
5. How leaders distribute rewards and status
6. How leaders recruit, select, promote, and dismiss

Leadership commitment to safety is one of the most crucial factors influencing cultural change, and the six points above exemplify how leadership signals the importance of safety compared to other factors.

Finally, it should be noted that Nævestad et al. (2018a) mention eight factors that influence safety culture change in companies, such as: Top management commitment throughout the intervention period, Employee engagement and support, Relationship between leaders and employees, Regulatory authorities' focus on safety (-culture) and support for companies, Clear implementation that aligns with existing measures, Organizational restructuring and other processes that can divert attention from the intervention.

4.2.2 Relevance

Working on safety culture is the most fundamental organizational safety measure because it addresses how safety is actually prioritized over other considerations in daily operations. Having well-developed systems and procedures has little effect if they are not used in the daily work and if there is no commitment to safety among managers and employees.

Table 4.2: Assessment of effects of safety culture measures.

Measure	Measure studied on buses?	Does the measure reduce accidents / injuries?	Target group of road users	How uncertain is the effect?	Is the measure in conflict with other measures?	Is the measure relevant?
Safety culture measures	Yes	Yes	Bus passengers and other road users	Medium, because it is difficult to pinpoint what elements are the most important	Uncertain, probably not	Yes, and it can be adapted to specific risk categories
10	2	3		2	0	3

4.3 Fleet management systems

Fleet management systems refer to various things. It is important to note this since we are evaluating studies of such interventions over a period of more than 20 years. The evaluated interventions generally involve a combination of drivers' self-monitoring using technology, control, and support from management. The interventions describe technological systems that record key parameters related to drivers' driving style, such as hard braking, acceleration, g-forces in turns, etc. The studied systems provide feedback to drivers on these parameters and give drivers opportunities to change their driving style. Several interventions can also be combined with customized training based on drivers' scores and other measures from management, such as internal competitions among drivers, bonuses for good scores and improvements, etc. These systems have undergone significant changes in recent years, with increasingly advanced parameters for driving style being recorded and increasing opportunities for automated aids for drivers (e.g., GPS-based adaptive cruise control).

The systems used today also focus on parameters for both safe and economical driving, including speed, sudden braking, acceleration, g-forces in turns, idling, fuel consumption, predictable driving, coasting, etc. (Nævestad 2022) These systems generate overall scores and sub-scores based on these parameters, which are regularly reviewed by company managers. Drivers also receive regular reports on their own scores; they can receive them daily or after each trip through the in-vehicle systems or mobile applications. Such systems are often combined with specially tailored training for drivers based on their individual scores.

4.3.1 Results from previous research

We rely on a previous literature review conducted by Nævestad et al. (2018a). This literature review focuses on the effects of various traffic safety measures targeting drivers in general and heavy goods vehicles specifically. Nævestad et al. (2018) identified a total of 7 studies that focus on fleet management technology and organizational follow-up and feedback on driving style.

The first study, conducted by Hickman and Geller (2003), examines drivers' self-management. The intervention involves drivers identifying target behaviors, selecting goals and strategies to promote and monitor their behavior. For 21 out of the 33 studied drivers, speeding was reduced by 30%, and extreme braking was reduced by 64% during the intervention. Hickman and Hanowski (2011) study a coaching intervention based on monitoring through built-in cameras and fleet management technology. The study found a significant reduction in recorded safety-related events by 37% (Company A) and 52% (Company B). Musicant et al. (2007) study the effect of feedback to drivers based on in-vehicle data recorders and conclude that feedback from IVDR led to a 40% reduction in the accident rate. Myers et al. (2012) investigate the effects of a DriveCam system that responds when G-forces are triggered and found a significant reduction over time for all events and for severe events per kilometer. Olson et al. (2009) study the effects of safety driving competition based on PC-based training, motivational interviewing, and self-monitoring. This study found a significant improvement in intentions for safe driving and hard braking. Toledo et al. (2008) examines the effects of feedback to drivers based on in-vehicle data recorders (IVDR) and found a significant reduction in all accidents but a small and nonsignificant increase in at-fault accidents. Wouters and Bos (2000) study the effects of driver feedback on acceleration, braking, and fuel consumption based on in-vehicle data recorders (IVDR) and found a 20% significant reduction in traffic accidents for vehicles with IVDR.

All the studies of fleet management systems reviewed in Nævestad et al. (2018) show positive results for traffic safety: safer driving and/or fewer accidents. However, the quality of the studies varies considerably. The main methodological challenges in these studies are that drivers' behavior may be influenced more by the fact that their behavior is being studied during the research period than by the feedback they receive from the equipment recording driving data. Such effects of being studied are referred to as "Hawthorne effects." Additionally, some of the studies lack control groups or pre-periods with the equipment installed to evaluate the significance of this mechanism. Hickman and Hanowski (2011), Wouters and Bos (2000), and Toledo et al. (2008) are examples of studies with relatively robust designs. However, only Wouters and Bos (2000) have a robust enough design with a before-and-after study with a control group. This study indicates a 20% decrease in accident risk as a result of fleet management systems providing feedback. This measure can also lead to a calmer driving style, thus resulting in fewer falls and injuries for passengers inside the bus. Therefore, it appears to be highly relevant to the injury picture. On the other hand, it should be noted that this measure is unlikely to prevent all hard braking incidents, such as those caused by unpredictable behavior of other road users. In this regard, it can be pointed out that the measure is likely to prevent a certain proportion of such incidents as well because it would likely result in a more predictable driving style and thus fewer conflicts (and collisions) with other road users. This measure can lead to the driver looking further ahead, driving more defensively, and adjusting speed better, increasing the chances of detecting potential conflicts.

The seven discussed studies, primarily involving heavy goods vehicles, are relevant to buses as they focus on heavy vehicles. One of the studies also focuses on buses, specifically coach buses (Wouters and Bos, 2000). This study is also the one with the highest quality. When discussing the relevance of the studies, it is important to remember that there are significant differences between driving a bus in urban areas and in more rural settings with highways. Driving in urban environments poses specific challenges in terms of driving style, such as more frequent stops and starts, more road users, and more (potential) conflicts, among others. It should be noted that the study by Wouters and Bos (2000) also includes taxi drivers. The impact of the measure is small to moderate because all the studies show positive effects, but only one of the studies has a sufficiently robust design.

4.3.2 Relevance

This measure is highly relevant, first because it is related to reduced accident risk in general, second because it also can reduce the occurrence of traffic accidents and injuries from passengers falling aboard buses. Analyses of accident data show that these incidents involve the highest number of injuries in bus transportation. Previous research also indicates that falls aboard buses are related to hard accelerations/decelerations (Elvik, 2019A), which is precisely what fleet management systems aim to reduce.

Table 4.3: Assessment of effects of fleet management systems.

Measure	Measure studied on buses?	Does the measure reduce accidents / injuries?	Target group of road users	How uncertain is the effect?	Is the measure in conflict with other measures?	Is the measure relevant?
Fleet management systems	Yes	Yes, up to 20% fewer traffic accidents	Drivers, but also passengers	Low to medium	No, it can also lead to reduced fuel consumption and emissions	Yes, particularly injuries inside the bus resulting from hard braking
11.5	2	3		2.5	+1	3

5 On-board passenger safety

5.1 Seat belts for passengers

Seat belts for passengers are not installed on all buses. Buses driving mostly on urban roads, have usually no passenger seat belts, even if the buses partly drive on motorways or other high-speed roads.

There are three categories of buses with different rules for the use of seat belts:

- Class 1 is a city bus, with more standing capacity than seats for the passengers, for example 30% seats, and these buses are exempted in the legislation from seat belts. There are, for example, 35-45 seats in a class 1 bus with a capacity of 137 passengers.
- Class 2 is a suburban/long-distance bus, where 40 percent of the bus's capacity can legally stand without a seat belt, while sitting passengers must use a seat belt.
- Class 3 bus is an express/tour bus where there are only seats, and where all passengers must wear seat belts.

Passenger seat belts may be two- or three-point belts. Even when installed, far from all passengers use seat belts.

5.1.1 Results from previous research

Effects of passenger seat belts on injuries have been investigated in a few empirical studies. Høye et al. (2022) has summarized the results from three empirical studies as follows: Compared to being unbelted, using any kind of seat belts reduces overall injury risk by about 20 percent. Serious injury risk is reduced by about 50 percent when using two-point belts and by about 80 percent when using three-point belts.

These results refer to seated passengers in buses which have installed passenger seat belts. Thus, the results cannot be generalized to buses which today have no passenger seat belts, such as many urban buses (class 1).

In roll-over crashes, no substantial differences were found between two- and three-point belts. However, three-point belts are more effective overall.

An indirect effect of seat-belt use among bus passengers is improved behavior. Belted passengers are per definition not standing, they leave their seat less often and are less distracting for the driver.

5.1.2 Relevance

We assess the relevance of seat belts in relation to these three bus types (*Feil! Fant ikke referanseilden..1*).

Class 1: We consider it not relevant to recommend fitting seat belts in city buses that have frequent stops (class 1). First, this can lead to longer stays at stops, as not everyone has unfastened their seatbelt when the bus stops. The average speed for city buses is 25-30 km/h, and the journey for a class 1 passenger is usually less than 15 minutes. The low speed is the most important premise for our conclusion. Second, some of the city buses, especially articulated buses, have seats facing opposite the direction of travel. It is unknown how seat belts will work in such seats (you can of course refrain from fitting them there). Third, the driver will have limited opportunities to check whether the belts are actually being used. Fourth, frequent, and partly incorrect, use will expose the belts to greater wear and tear than seat belts that are not fastened and unfastened as often. Fifth, there are fewer seats in Class 1 buses than in other bus classes, and if one were to calculate the

safety effects of seat belts for these seats, they would only apply to some of the passengers. We discussed this measure with some of the bus company representatives in Nævestad et al. (2020), and they said that this was not something they had focused much on in their risk analyses. It was also mentioned that there had been no serious injuries related to missing seat belts and standing passengers in class 1 buses.

The assessment above is given on the basis of the low average speed of the class 1 buses. Despite knowing that class 1 buses have a low average speed, we are unsure how often and to what extent class 1 buses are used on roads with higher speeds. We recommend mapping this and carrying out risk analyzes of missing seat belts and standing places for potentially high speeds. This is also an important area for future research. We also recommend that future research examines possible injuries related to incidents in class 1 buses, with a focus on the number of injuries on board among standing passengers and seated passengers without seat belts in accidents/sudden stops, as well as severity of the accident and the speed of the bus when the accident occurred.

Seat belts in Class 1 buses get the lowest score of the three bus classes in the table below, because there are the fewest seated passengers who can use a seat belt in Class 1 buses, because it can conflict with accessibility and regularity, and because of the four further complicating factors that we have discussed above.

Class 2: Class 2 buses will have the same challenges related to seat belts as class 1 buses, but in class 2 buses there are more seats and requirements for seat belts for these. Unlike Class 1 buses, class 2 buses are also used more on roads with a higher speed limit. This means a higher risk of injury for (seated) passengers who may not be wearing seat belts on Class 2 buses, and a higher risk of injury in the event of a fall for standing passengers.¹

Given that 40 percent of the bus's passengers legally can stand without a seat belt in class 2 buses, and these buses primarily operate in regional traffic outside the city center, it may be relevant to investigate how often the incident type "fall in bus" occurs among people standing on class 2 buses in high speed. This is an important question for future research. With a large proportion of standing passengers, the degree of injury can increase considerably with increased speed. It is therefore important to assess where these buses are used, i.e. the speed on the roads where they travel, and any injuries in the event of accidents and near misses (sudden stops), for seated passengers without seat belts in the event of accidents, and the Injury severity level for standing passengers in the event of a fall at higher speeds.² Risk analyzes of the risks associated with standing passengers on class 2 buses should be carried out. Such data can possibly also form the basis for more principled discussions about the regulations for seat belts and standing places in such types of bus and possible measures.

Seat belts in Class 2 buses get the second highest score of the bus classes, because this measure will have an effect for 60% of the passengers on the bus.

¹ In Nævestad et al (2020), the drivers who drive regional buses expressed the highest concern about passengers not wearing seat belts in collisions, and this can perhaps be connected to the fact that these buses have a higher average speed than, for example, the articulated buses, where the drivers have the lowest concern.

² Some of the interviewees in Nævestad et al (2020) emphasized that it is "difficult to explain to passengers that it is safe to stand on buses traveling at 70-80 km/h per hour", so these are issues that several of the interviewees saw as relevant. This was mentioned by several different parties. It was also mentioned that in Sweden there is a recommendation that all passengers in class 2 buses must wear seat belts, although it is not a requirement.

Class 3: In Class 3 buses, there are no standing passengers, and here seat belts will be relevant to minimize injury in collisions, as is assumed in previous research. In the table below, we assigned the highest score for relevance to Class 3 buses, because this measure will have an effect for everyone on the bus, since everyone can use a seat belt.

In **Feil! Fant ikke referansekilden..1**, we assess passenger seat belt use under the assumption of the regulations that exist for the number of seats in the buses. It would perhaps be just as relevant to also assess the effects of the rules for standing passengers in the various bus classes (i.e., to only have seats with belts in the buses and remove places for standing). We have commented on this for class 2 buses, and possibly class 1 buses that may drive at high speeds.

Table 5.1: Assessment of effects of seat belt measures for class 1 and class 2 buses.

	Measure studied on buses?	Does the measure reduce accidents / injuries?	Target group of road users	How uncertain is the effect?	Is the measure in conflict with other measures?	Is the measure relevant?
Seat belt in class 1 buses	Yes, but there are few studies	Yes: -20% injuries, -50% serious injuries; -80% serious injuries for 3-point belt.	Seated passengers	Medium	Yes: Possible conflict with accessibility / regularity	Yes, maybe
5	2	1		2	-1	1
Seat belt in class 2 bus	See class 1	See class 1	See class 1	See class 1	No	Yes, highly relevant
9	2	2		2	0	3
Seat belt in class 3 bus	See class 1	See class 1	See class 1	See class 1	No	Yes, highly relevant
10	2	3		2	0	3

5.2 Design of passenger seat backs

Shape and materials on passenger seats can affect injury risk among bus passengers, both in collisions and in non-collision falls.

Some studies (Høye et al., 2022) show that high seat backs reduce injury risk for passengers, including those who are sitting both with and against driving direction. Injury severity may also be affected by the type of materials used, i.e., the degree to which seat backs are deformable and energy absorbing.

Passenger seat back design is obviously relevant since passengers may hit them in collisions and falls. However, we are not aware of any empirical studies that are based on real-world crashes. Moreover, the measure is not well-defined in the sense that it is not either present or absent. For energy absorbing properties, the relationship with injury severity cannot even be expected to be linear; somewhat energy absorbing seat backs can be expected to inflict less serious injuries; however, highly energy absorbing seat backs would be so flexible that they would miss their point as seat backs.

Table 5.2: Assessment of effects of passenger seat back design.

	Measure studied on buses?	Does the measure reduce accidents / injuries?	Target group of road users	How uncertain is the effect?	Is the measure in conflict with other measures?	Is the measure relevant?
Passenger seat back design	Not in real-world accident studies	Probably	All passengers	Highly, and the measure is not well-defined	No	Yes

	Measure studied on buses?	Does the measure reduce accidents / injuries?	Target group of road users	How uncertain is the effect?	Is the measure in conflict with other measures?	Is the measure relevant?
4	1	1		1	0	1

5.3 Crash-friendly design and positioning of handrails

Passengers on buses need handrails, grab handles etc. to hold on to while standing or moving through the bus. This is most important on buses where not all passengers are seated at all times, but even on buses where passengers are seated while driving, they may need something to hold on to when moving between seats and doors. Handrails and grab handles may be under the ceiling of the bus where they cannot be hit (except in a roll-over). However, far from all passengers are tall enough to be able to reach such handles.

In collisions and falls, passengers often sustain injuries when they hit handrails or handles on seat backs. It is difficult to make these more energy-absorbing. It is therefore important to choose shape and positioning in a way that minimizes injury risk.

In collisions, seated passengers often sustain injuries from hitting the seat back in front, especially when they have horizontal handles. Replacing horizontal by vertical handles can probably prevent many such injuries.

As for seat back design, the design and positioning of handrails, handles etc. is considered to be relevant. However, this is not a well-defined measure that is either present or absent and we are not aware of any real-world accident studies that have investigated effects on injuries.

Table 5.3: Assessment of effects of the design and positioning of handrails.

	Measure studied on buses?	Does the measure reduce accidents / injuries?	Target group of road users	How uncertain is the effect?	Is the measure in conflict with other measures?	Is the measure relevant?
Design and positioning of handrails	Not in real-world accident studies	Probably	All passengers	Highly, and the measure is not well-defined	No	Yes
3	0	1		1	0	1

5.4 Securing wheelchairs and baby buggies

Wheelchairs and baby buggies are usually placed in the open area near the doors of the bus. Both in collisions and while driving, they may sustain injuries from hitting objects (such as seats or handrails) or other passengers, from tipping over, or from being hit by other passengers or objects (e.g., baggage).

Potential measures to reduce injury risk related to wheelchairs and baby buggies:

- Securing wheelchair / baby buggy with belts
- Design and positioning of handrails and grab handles
- Reducing the numbers of unsecured other passengers and baggage.

Measures for wheelchair users and baby buggies are obviously relevant, although we have no basis for evaluating injury effects or assessing how injuries potentially may be affected.

Collecting information that would allow such assessments, would be a first step.

Table 5.4: Assessment of effects of measures to secure wheelchairs and baby buggies.

	Measure studied on buses?	Does the measure reduce accidents / injuries?	Target group of road users	How uncertain is the effect?	Is the measure in conflict with other measures?	Is the measure relevant?
Measures to secure wheelchairs and baby buggies	Not in real-world accident studies	Probably	All passengers	Highly, and the measure is not well-defined	No	Yes
4	0	1		1	0	2

5.5 Measures to prevent fall accidents

5.5.1 Results from previous studies

As noted in section 3, fall accidents on board buses, or accidents related to on- and off boarding are a major source of injuries in bus transport. Although these incidents are not traffic accidents, and in most cases only result in minor injuries, the possibilities for preventing them should be discussed.

Falling accidents in buses are difficult to prevent. Firstly, it only takes a small change in speed or direction for a standing passenger to fall or lose their grip around what they are holding on to.

Secondly, some preventive measures have ambiguous effects. For example, a pole is both a help, in that you can hold on to it, and a danger, in that you can strike against it if you lose your grip. Removing stairs by the doors, as the bus has a low floor, is a similar example. You can get on and off a low-floor bus without going up a flight of stairs, but the bus often has to have internal stairs, since not all seats can be low-floor seats. The danger with a staircase at the door is replaced by the danger from stairs inside the bus.

Thirdly, it is expected that an increasing proportion of bus travelers will belong to groups that are particularly prone to falling, especially older women. This is because the number of elderly people in society is increasing and that transport policy in cities and towns encourages people to travel by public transport rather than driving a car.

Several measures that may reduce the risk of falling on board a bus or when getting off or getting on:

- **Weaker acceleration or deceleration.** The bus will then take longer to stop and attain cruising speed again. The consequence may be that the route times have to be extended. There is also reason to believe that many fall injuries occur due to unexpected sudden braking or evasive maneuvers, not during regular stops for which many passengers are prepared.
- **High-friction floor.** Falls that start with slipping can then possibly be reduced. However, it will be impossible to avoid that the floor may become partly wet and thus smoother.
- **Grip-friendly handrails and handles.** Today, posts and handles are usually painted or lacquered in a fairly smooth material. If you are a little sweaty, or have slippery gloves on, the friction is low, and it is easy to lose your grip.
- **Low floor buses.** This can reduce fall injuries when getting on and off, but internal stairs in the bus represent a new point of danger.
- **Prohibition of standing places.** Buses in long-distance traffic, for example the airport bus in Oslo, can operate without standing places. In city buses, it is difficult to imagine that standing places can be avoided.

All these measures have their obvious limitations. None of them can be expected to significantly reduce the number of fall injuries. It is nevertheless natural that a company that wants to focus on safety pays attention to the problem of fall injuries.

Future self-driving buses can possibly reduce the problem, at least if these buses have a low floor, no internal stairs and no standing capacity. In theory, it should be possible to achieve this, since a driver is not needed and the economies of scale you have in today's bus operation (that a driver serves as many passengers as possible) disappear in the long run. You can then build smaller buses that have such frequent departures that standing spaces can be avoided. The buses can also be programmed for lower acceleration and deceleration and, when the technology is mature enough, will have systems that detect dangerous situations quickly enough that sudden braking can often be avoided.

5.5.2 Relevance

The incident data shows that this is the type of incident with the most injuries and the highest proportion of injuries. Therefore, measures to prevent fall accidents are highly relevant. However, this is not a single well-defined measure.

Table 5.5: Assessment of effects of measures to prevent fall accidents.

Measure	Measure studied on buses?	Does the measure reduce accidents / injuries?	Target group of road users	How uncertain is the effect?	Is the measure in conflict with other measures?	Is the measure relevant?
Measures to prevent fall accidents	Yes, but measures are hypothetical	Maybe, quantification is impossible	Standing passengers: passengers embarking/disembarking	high	Weaker retardation/ acceleration could result in longer trip duration	Yes, applies to a large portion of injuries, but uncertain what the exact measure is
5	1	1		1	-1	3

6 Crashworthiness and driver protection

Crashworthiness and driver protection are most relevant in head-on collisions, in run-off road accidents, and in rollovers. In this section, we discuss crashworthiness in general, which is relevant both for driver protection and for passenger safety, as well as seat belt use among drivers. On-board passenger safety and crash protection for vulnerable road users, are discussed in other sections.

6.1 Crashworthiness in head-on collisions and run-off-road crashes

Crashworthiness is the «ability of a structure to protect its occupants during an impact³». Crashworthiness of buses depends on two main factors (Jongpradist et al., 2015, 2022):

- **Structural integrity:** How much space is left for occupants after an impact (“survival space”)
- **Energy absorption:** How much collision energy is absorbed by structural components; the more energy that can be absorbed, the less severe will the collision be for occupants.

Improving one of these factors will often be negative for the other. For example, increasing the rigidity of a structure may improve survival space but will reduce energy-absorbing properties.

Both structural integrity and energy absorbing properties of buses depend on a number of factors, such as the choice of materials, structural properties and reinforcements, and dedicated crumple zones.

The most important types of accident where bus crashworthiness is relevant, are head-on collisions and run-off-road accidents, especially roll-over accidents.

The design of buses exterior will also affect injuries among other road users in collisions with buses. This is discussed for vulnerable road users in section 7.

In collisions with other motor vehicles, better protection against deformation in the bus is generally related to higher severity for crash partner occupants.

Figure 6.1 illustrates the importance of structural integrity of the bus front, in an accident where two buses collided at a speed of about 33 km/h in November 2017. Each bus front penetrated the other front with 1 meter in the collision. The driver of the eastbound bus was killed instantly, and the driver of the westbound bus was critically injured.

³ <https://en.wikipedia.org/wiki/Crashworthiness>



Figure 6.1: Damages to the front of the Eastgoing bus in the Nafstad accident in Norway, November 2017. Source: Accident Investigation Board Norway (AIBN) (AIBN Report Road 2019/04). Left picture from the front and right picture shows the damage to the bus front seen from above.

6.1.1 Results from previous research

Buses have normally good structural integrity for passengers, but less good for the driver. The following figure is taken from a report on a collision between two buses at Nafstad (Norway) in November 2017 (National Accident Investigation Board 2019), shows requirements for safety beams and voluntary reinforcement on buses and trucks.

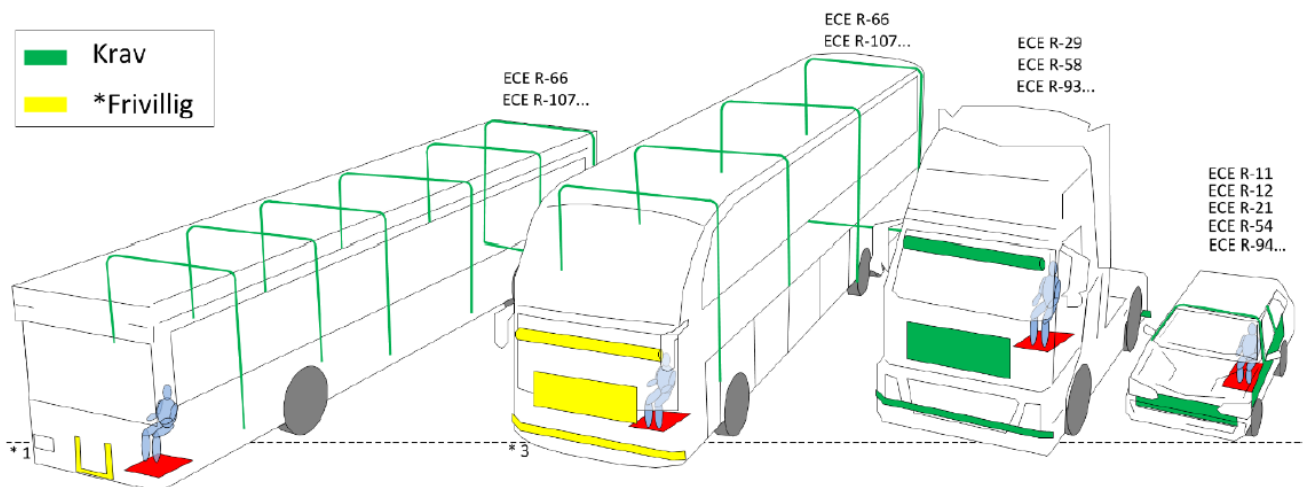

Figure 6.2: Mandatory and voluntary measures for structural integrity on buses (The Accident Investigation Board, Norway, report road 2019/04, figure 26); green (“krav”): mandatory, yellow (“frivillig”): optional.

Safety beams are required on buses to prevent the walls and roof from being pressed in when the bus overturns. The compartment for passengers is then preserved intact and a survival space is ensured for passengers.

Technical tests under controlled conditions (Cichocki & Wekezer, 2007, Kwasniewski et al. 2009, Gepner et al. 2014) show that safety beams help prevent deformation of the passenger compartment.

There is no requirement for safety beams around the driver's seat in buses, as it is in both trucks and passenger cars (green beams in the front of trucks and passenger cars in **Feil! Fant ikke referansekinden.**). Bus drivers are therefore very vulnerable in frontal collisions, especially in collisions with other buses or trucks or with solid structures (e.g., walls, bridge pillars).

No studies have been found that specifically address protection measures for bus drivers against injuries in accidents. It should be technically possible for the driver's seat to be protected by a reinforced bumper or underrun barrier in front, a safety beam at the bottom of the windscreen, as well as safety beams in the window pillars, in the same way as in a passenger car. Figure 6.3 shows as an example how the driver's place may be designed as a separate module with enhanced safety, modeled after the driver's compartment in train sets of type BM 74 and BM 75 ("Flirt"), which is today the most common type of train set in operation in Norway.

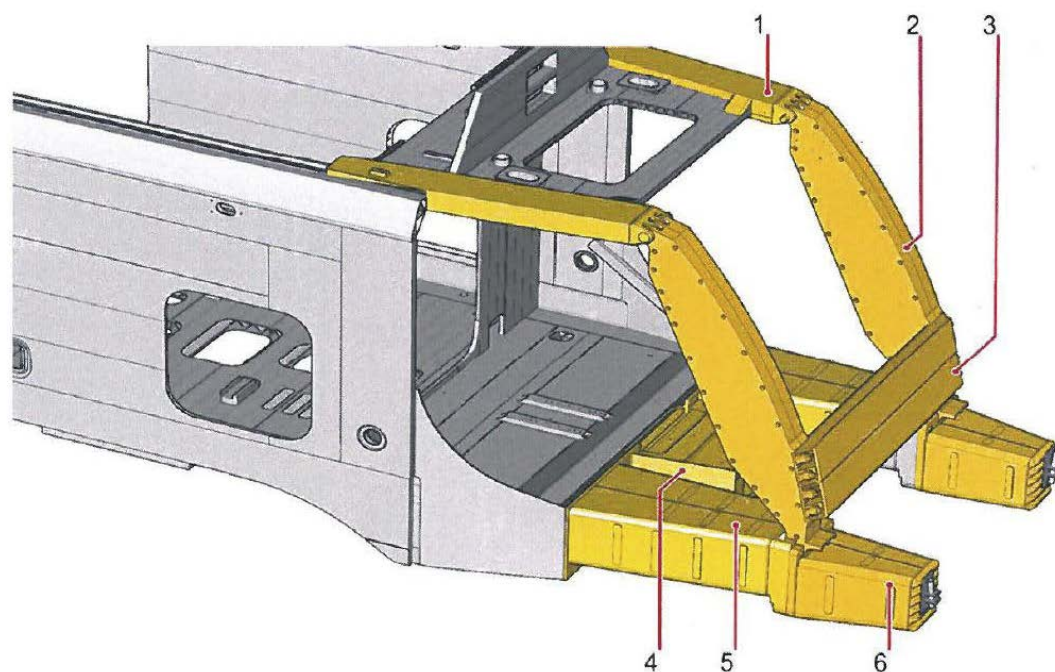

1	Collision frame	4	Open space for coupling ("kobell")
2	Articulated A beam	5	Absorption boxes
3	Reinforcement collision beam	6	Buffer with anti-climb function

Figure 6.3: Reinforced drivers compartment in train set type 74 and 75 (The Accident Investigation Board, Norway, report 2013/02, figur 25).

The reinforced driver's compartment in the train sets is designed for a speed of more than 200 km/h. In a bus, a construction with smaller dimensions will be able to function satisfactorily. However, the construction principles should be transferable to buses. The buffer (number 6 in figure V2.2) can be replaced by a reinforced bumper or underpass barrier.

On buses, wide A-pillars (number 2 in Figure 6.3) increase the blind spot problem for buses. Also, the A-pillars should hardly be movable, as they are in the train set. The blind spot problem and how A-pillars affects injuries among pedestrians and cyclists, are discussed in other sections of this report.

6.1.2 Relevance

Crashworthiness is very relevant because bus drivers have a higher accident risk than passengers. Especially head-on collisions may be fatal, even at low speeds.

Table 6.1: Assessment of effects of crash protection for bus drivers

Measure	Measure studied on buses?	Does the measure reduce accidents / injuries?	Target group of road users	How uncertain is the effect?	Is the measure in conflict with other measures?	Is the measure relevant?
Crash protection for bus drivers	Yes, experiments have been conducted	Yes, but difficult to quantify	Mainly bus drivers	Medium	No	Yes, but not the largest portion of injuries
8	2	1		2	0	3

6.2 Increasing seat belt use among bus drivers

All buses have driver seat belts. However, not all drivers are using seat belts. Information about seat belt use among bus drivers in Norway is lacking. We know, however that seat belt use among heavy vehicle drivers has increased significantly in recent years. In 2019, 85% of all heavy goods vehicle drivers wore a seat belt.⁴ We do not have corresponding shares for bus drivers.

Empirical studies among truck drivers show that seat-belt use reduces injuries by about 20 percent and fatalities by about 50 percent (Høye et al., 2022). These results are based on truck drivers. For bus drivers, seat belt use can also be expected to reduce injuries. However, the size of the effect is uncertain.

The vulnerability of bus drivers in head-on collisions with other buses or trucks was demonstrated in a collision between two buses in Norway in November 2017. One driver died and the other was very seriously injured, although both buses were only traveling at a speed of just over 30 km/h at the time of the collision.

Measures to increase seat belt use among bus drivers include mainly technical measures. Seat-belt reminders are already installed in all buses. Seat belt interlocks would prevent buses from being operated unless the driver seat belt is fastened. Both types of measures can relatively easily be circumvented by the driver by fastening the seat belt behind the back.

Seat belt use among bus drivers is highly relevant. However, we have no information for assessing the relevance of specific measures to increase seat belt use.

Table 6.2: Assessment of effects of increasing seat belt use among bus drivers.

Measure	Measure studied on buses?	Does the measure reduce accidents / injuries?	Target group of road users	How uncertain is the effect?	Is the measure in conflict with other measures?	Is the measure relevant?
Increasing seat belt use for bus drivers	No, for truck drivers, but should be relatively comparable	Yes, but difficult to quantify	Bus drivers	Low	No	Yes, but not the largest portion of injuries, and only for a small <u>unknown</u> share of non-users
Score: 8,5	1,5	3		3	0	1

⁴ <https://www.vegvesen.no/globalassets/fag/fokusomrader/trafikksikkerhet/national-plan-of-action-for-road-safety-2022-2025---short-version-in-english.pdf>

7 Crash protection for vulnerable road users

With crash protection for vulnerable road users (VRUs) we mean all measures and properties of buses that affect injury severity among VRUs, mostly pedestrians and cyclists, who are hit by a bus.

In Norway in 2021-2022 19 percent of injury accidents with buses were pedestrian accidents and in 19 percent of these, someone (assumably the pedestrian) was killed or seriously injured (KSI). The following figure shows the distribution of speed limits in pedestrian accidents involving buses in Norway (2021-2022, data labels refer to accident numbers):

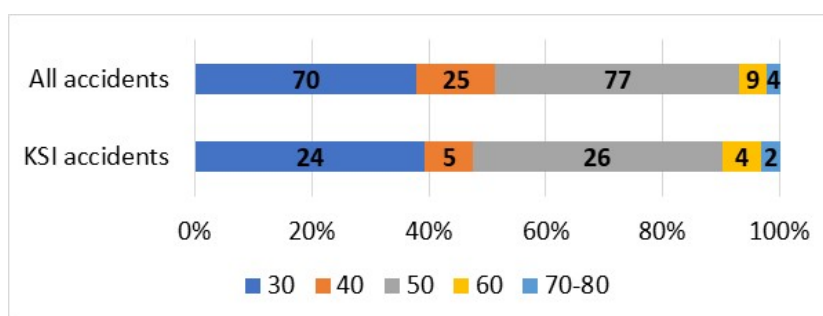

About half of all bus-pedestrian collisions are on roads with speed limits of 30 or 40 km/h. There is no big difference between accidents with and without killed or seriously injured (KSI). The proportion of accidents at speed limits of 50 km/h or above, is 52 percent among accidents with KSI and 47 percent among accidents without KSI.

The following figure shows the distribution of impact points on the bus in collisions between a bus and a pedestrian or cyclist in London (2006-2015; Martin et al., 2019):

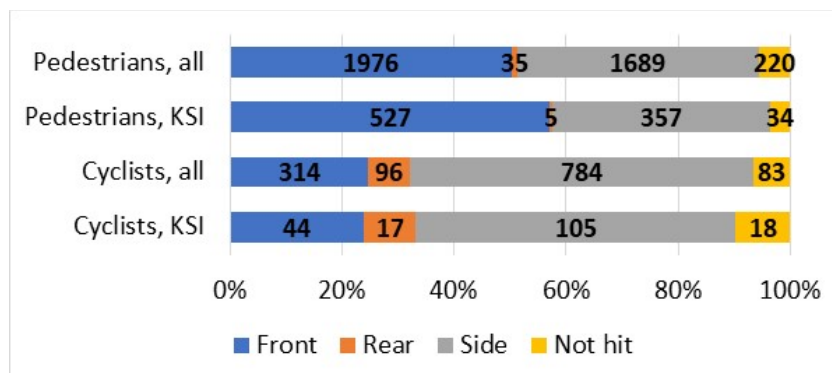

Most pedestrians were hit by the front of the bus, many were hit by the side and only few by the rear. The proportion of injured pedestrians who were KSI, was greatest when they were hit by the front of the bus (27 percent), followed by those hit by the side (21 percent) and least by those hit by the rear end of the bus (14 percent).

Among cyclists, most were hit by the side of the bus. Such collisions happen typically when a bus overtakes a cyclist, either midblock or at intersections, where the bus is turning right and the cyclist goes straight ahead.

Martin et al. (2019) show additionally (details available in the Martin-report):

- Most buses that hit pedestrians had been driving straight ahead
- Most pedestrians hit by a bus had come from the side (from the bus drivers perspective)

- Most cyclists hit by a bus had been cycling straight ahead.

Martin et al. (2019) describe the following factors that affect injury risk and severity among VRUs in collisions with buses:

- The shape of the front of the bus, including the windscreen and position of hard objects
- Energy-absorbing properties of the front of the bus
- The likelihood of being run over by the bus and specific measures to prevent run-over risk.

Additionally, the speed of the bus will affect injury severity, especially when the pedestrian or cyclist is hit by the front of the bus.

7.1 Front-end design

How the front end of the bus is designed, affects:

- Injuries sustained by VRUs in direct impacts on the front of the bus, where the head often is the most seriously injured body part
- The risk of being run over by the bus depends mainly on the shape of the front of the bus; such accidents are on average far more severe than other VRU-bus collisions

Sloped front: A slightly sloped front reduce run-over risk by deflecting the VRU laterally and slightly upwards. A sloped front can also reduce head injuries in collisions when a pedestrian is hit by the bus because legs and upper body absorb some of the collision energy.

However, there will be some “sweet point” (not quite appropriate wording in this context). Too sloped fronts may unnecessarily increase leg injury risk and the pedestrians head may accelerate so much that head injury increases, instead of decreasing.

Rounded corners: Rounded corners in the front of the bus reduce run-over risk by deflecting the VRU laterally and slightly upwards. However, depending on the design, rounded corners may accelerate the pedestrian and increase the risk of being run over by other vehicles (Martin et al., 2019).

A critical question is also the placement of the A-pillars, where a number of different consequences have to be balanced. Amongst other things, A-pillars are sight obstructions, and they may inflict injuries to pedestrians. If the windshield is rounded, this will allow moving the A-pillars backwards, but it will require a harder and stiffer material which will be less energy-absorbing (Martin et al., 2019).

Energy absorbing bus front: The energy-absorbing properties of a bus front may be improved by the choice of energy-absorbing materials and avoiding hard spots under the front panels (Martin et al., 2019). Avoiding wiper mount points at the bottom of the windshield (and moving them to the top) will also contribute. Alternatively, the mount points may be covered by an energy-absorbing lid or cover plate.

Windshield replacement: Windshields on buses are often repaired or replaced. An Australian study shows that replacements are often not in accordance with OEM-requirements, which may greatly and negatively affect injuries sustained by VRUs hit by a bus with a replaced or repaired windshield (Kennett et al., 2016).

7.1.1 Results from previous research

We have not found any real-world accident studies that have investigated relationships between the front-end design of buses and injury risk or severity among VRUs in collisions with buses.

7.1.2 Relevance

The front-end design of buses is highly relevant in bus-VRU collisions, but it is not possible to assess quantitatively.

Table 7.1: Assessment of effects of the front-end design of buses.

Measure	Measure studied on buses?	Does the measure reduce accidents / injuries?	Target group of road users	How uncertain is the effect?	Is the measure in conflict with other measures?	Is the measure relevant?
Front end design	Not in real-world accident studies	Yes, but not quantified	VRUs hit by buses	Highly	No (except partly with itself)	Yes
3	0	1		1	0	1

7.2 Run-over guards and pedestrian airbags

Run-over accidents in which a VRU is run over by a bus may be prevented by specific measures. To our knowledge, no such measures are on the market specifically for buses today. Potential measures described by Martin et al. (2019) include:

- Devices on the front and side of the bus, comparable to underrun guards on trucks, such as “BodyGuard” by Bombarier (which is for trams)
- Devices under the bus, so called «body-catcher-devices» that are activated once a VRU has come under the bus, and which prevents contact with the front axle
- Pedestrian airbags («deployable run-over airbags» or «inflatable frontal VRU run-over guards» which are activated by the same sensors as VRU collision warning; such airbags are under development.

Table 7.2: Assessment of effects of Run-over guards / pedestrian airbags.

Measure	Measure studied on buses?	Does the measure reduce accidents / injuries?	Target group of road users	How uncertain is the effect?	Is the measure in conflict with other measures?	Is the measure relevant?
Run-over guards / pedestrian airbags	No	Yes, but not quantified	VRUs hit by buses	Highly	No	Yes
3	0	1		1	0	1

7.3 Remove side mirrors

In London, 1.9 percent of pedestrians and 0.5 percent of cyclists hit by buses were hit by one of the side mirrors on the bus. Replacing side mirrors by camera systems removes side mirrors and thus the risk of being hit by one (Martin et al., 2019).

Other effects of camera systems are described elsewhere in this report.

We do not assess the relevance of removing side mirrors separately, this will be included in the assessment of camera systems (blind spot monitoring).

8 Driver assistance systems – mandatory systems

In this chapter we describe driver assistance systems that already are mandatory on buses or that will become mandatory during the next years.

According to EUR-Lex (2022) the following measures are mandatory on all new bus types since 2022 and will be mandatory on all new buses from July 7, 2024:

- Intelligent speed assistance (ISA)
- Reversing detection
- Blind spot monitoring
- Distraction warning
- Event data recorders
- Collision warning for pedestrians and cyclists
- Emergency stop signal
- Tire pressure monitoring

Top speed limiter and antilock brakes (ABS) are already mandatory on all buses.

Systems that are not currently mandatory on heavy vehicles, are discussed in the following chapter.

8.1 Top speed limiter

In Norway and Europe, all heavy vehicles (over 3.5 ton) must have a top speed limiter⁵. The maximum speed cannot be higher than 100 km/h for buses of the types M2 and M3 which have seats for more than eight passengers. It is difficult to hypothetically assess the share of accidents caused by higher speeds than 100 km/h. We might, however, expect that long distance express buses that mainly drive on highways has a considerable safety benefit from limiting the speed to maximum 100. This is not likely to be relevant in other contexts, e.g., urban settings with low speeds.

Table 8.1: Assessment of effects of top speed limiter.

Measure	Measure studied on buses?	Does the measure reduce accidents / injuries?	Target group of road users	How uncertain is the effect?	Is the measure in conflict with other measures?	Is the measure relevant?
Top speed limiter	No	Yes, perhaps in some cases	All	High	No	Difficult to assess
3	0	1	0	1	0	1

8.2 Intelligent speed assistance (ISA) – Warning ISA

ISA will be mandatory on all new buses from 2024 (EUR-Lex, 2022):

“... a system to aid the driver in maintaining the appropriate speed for the road environment by providing dedicated and appropriate feedback”

⁵ <https://www.tshandbok.no/del-2/4-kjoeretoeyteknikk-og-personlig-verneutstyr/4-33-toppartssperre/>

This does not include ISA of the type that makes it difficult (by producing counter-pressure to the accelerator pedal) or impossible to drive over the speed limit.

Data collected by the Norwegian Public Roads Administration (Statens vegvesen mfl. 2019) suggest that compliance with speed limits has improved during the period 2006-2018. However, these data are based on all traffic and do not specify individual vehicle types, such as buses.

Speed limit compliance among buses in Norway is unknown. Top speed limiters do not prevent speeding on most roads. For buses operating on scheduled routes in urban traffic, violations of speed limits are likely rare because of traffic density, signalized intersections, and frequent stops. Therefore, the potential for reducing accidents and injuries by installing ISA in buses is probably far less than for passenger cars. There is not enough reliable data to quantify the potential.

8.2.1 Results from previous research

ISA can potentially increase accident numbers and severity by reducing speed. However, we have no information about how much buses exceed the speed limit. In fatal accidents in Norway in 2005-2021, 99 buses were involved in 89 accidents. Only three of the buses had exceeded the speed limit by significant amounts (Høye & Elvik, 2023).

Studies from other countries also found relatively small proportions of crash involved buses that had been speeding (around 3-5 percent). Bus accidents are far more often related to inattention, distraction and yielding violations than to high speed (Høye & Elvik, 2023). We also lack information about the effect of warning ISA on speed limit compliance among bus drivers.

8.2.2 Relevance

This measure is attributed low relevance, as our data does not indicate that driving well over the speed limit is an important contributory factor in accidents.

Table 8.2: Assessment of effects of Intelligent Speed Adaptation (ISA).

Measure	Measure studied on buses?	Does the measure reduce accidents / injuries?	Target group of road users	How uncertain is the effect?	Is the measure in conflict with other measures?	Is the measure relevant?
Warning ISA	No	Could possibly lead to a slight decrease	Everyone involved in accidents with buses	Low	No. Lower speeds might reduce emissions.	No
5	0	1		3	+1	0

8.3 Reversing detection

Reversing detection or assistant will be mandatory on new buses from 2024 (EUR-Lex, 2022):

“... Reversing detection with camera or sensors: a light-signalling function to indicate to other road users to the rear of the vehicle that a high retardation force is being applied to the vehicle relative to the prevailing road conditions”

Reversing assistant systems have rarely been studied in real-world accident studies. Høye et al. (2022) have summarized empirical evidence. They conclude that the effect on accidents is highly uncertain. The effects are most likely small. Behavioral adaptations may even increase accident risk which has been found in one empirical study.

Based on the currently available empirical evidence, it is not possible to assess the relevance of reversing assistants.

Table 8.3: Assessment of effects of reversing detection.

Measure	Measure studied on buses?	Does the measure reduce accidents / injuries?	Target group of road users	How uncertain is the effect?	Is the measure in conflict with other measures?	Is the measure relevant?
Reversing detection	No	Maybe	Everyone involved in accidents with buses	Low	No.	Yes maybe
3	0	1		1	0	1

8.4 Blind spot monitoring and warning systems

Blind spot warning systems will be mandatory on new buses from 2024 (EUR-Lex, 2022):

“Vehicles of categories M2, M3, N2 and N3 shall be designed and constructed to enhance the direct visibility of vulnerable road users from the driver seat, by reducing to the greatest possible extent the blind spots in front of and to the side of the driver, while taking into account the specificities of different categories of vehicles”

From 2029 the following is mandatory (tung.no):

«... improved physical field of view: Rules that improve the drivers’ vision out of the windows and thus reduce blind zones»

Blind spot cameras and warning systems aim to reduce accidents where a bus driver overlooks another vehicle or VRU in one of the blind spots of the bus. Buses have large blind zones, especially on the right side of the bus, in the area not covered by the right exterior mirror.

Extra mirrors were not found to reduce blind spot related accidents in a Danish experimental study (Behrendorff & Hansen, 1994). Problems with mirrors are that drivers cannot look into several mirrors at the same time, and that mirrors often are not correctly adjusted.

Blind spot monitoring technology has developed a lot since the 1990s and blind spot cameras can potentially cover all blind zones on a bus (Koutellis et al., 2011). Potential limitations for the effectiveness of camera systems is that the driver actively has to look at the monitors, and that the monitors can be distracting.

A system that alerts the driver to a dangerous situation, provided that false alarms are avoided, avoid some of these problems.

8.4.1 Results from previous reserach

Empirical evidence from real-world accident studies for the effectiveness of blind spot warnings is lacking (Høye et al., 2022). Some studies have investigated potential effects (e.g., Englander et al., 2017) and show that blind spot monitoring and warning systems theoretically can prevent blind-spot related accidents.

8.4.2 Relevance

Based on the currently available empirical evidence, it is not possible to assess the effectiveness of blind spot monitoring and warning systems.

Table 8.4: Assessment of effects of blind spot monitoring and warning systems

Measure	Measure studied on buses?	Does the measure reduce accidents / injuries?	Target group of road users	How uncertain is the effect?	Is the measure in conflict with other measures?	Is the measure relevant?
Blind spot monitoring / warning	Not in real-world accident studies	Yes, probably; difficult to quantify	Other motor vehicles and VRUs	Highly	No	Yes
5	2	1		1	0	1

8.5 Driver distraction warning

«Attention warning in case of driver drowsiness or distraction» will be mandatory on new buses from 2024 (EUR-Lex, 2022; from 2026 according to tung.no, 2023).

EUR-Lex (2022) gives two different definitions, and it is unclear which of these systems will become mandatory:

'Driver drowsiness and attention warning' means a system that assesses the driver's alertness through vehicle systems analysis and warns the driver if needed.

'Advanced driver distraction warning' means a system that helps the driver to continue to pay attention to the traffic situation and that warns the driver when he or she is distracted.

Driver distraction warning systems have not been evaluated empirically. Literature searches yield many studies that have tested different ways to measure distraction or drowsiness. However, we have not found studies that have evaluated such systems in real traffic or in accident studies.

Simulator studies show that such systems may detect distraction and prevent drivers from falling asleep. However, drivers find them often quite irritating.

For assessing the relevance of driver distraction warning systems, we would need information about the prevalence of distraction and sleepiness, as well as the effect of such systems on distraction, sleepiness and crash involvement. Although accident investigations show that a large proportions of fatal road accidents in general in Norway (about 50%) involve distraction and/or fatigue (Hesjevoll et al 2022), we do not know whether these types of distraction or fatigue can be prevented by the types of warning system that exists.

Table 8.5: Assessment of effects of driver distraction warning.

Measure	Measure studied on buses?	Does the measure reduce accidents / injuries?	Target group of road users	How uncertain is the effect?	Is the measure in conflict with other measures?	Is the measure relevant?
Driver distraction warning	No	Unknown	All	Highly	No	Uncertain due to lack of evidence
2	0	0	All	1	0	1

8.6 Event data recorder

Event data recorders will be mandatory on new buses from 2024 (EUR-Lex, 2022; from 2029 according to tung.no, 2023):

“... a system with the only purpose of recording and storing critical crash-related parameters and information shortly before, during and immediately after a collision”

These are systems which only save data in the case of an accident (“only purpose”). Thus, they cannot be used to collect data for other purposes such as driver incentive systems. There are to our knowledge few studies of this. One exception is Myers et al (2012), who study DriveCam onboard event recorder, which provides data before and after g-forces are triggered. The study involved 54 ambulances and found a significant decrease over time in number of all events and severe events per mile, with use of the recorder. This is, however, a descriptive study without control. Any effects on accident involvement are unknown.

Table 8.6: Assessment of effects of event data recorder.

Measure	Measure studied on buses?	Does the measure reduce accidents / injuries?	Target group of road users	How uncertain is the effect?	Is the measure in conflict with other measures?	Is the measure relevant?
Event data recorder	Maybe	Unknown	All	Highly	No	Uncertain due to lack of evidence
2.5	0.5	0	All	1	0	1

8.7 VRU-collision warning and automatic emergency brake (AEB)

Collision warning for VRUs with automatic emergency brake (AEB) will be mandatory on new buses from 2024 (EUR-Lex, 2022):

“Warnings to prevent collisions with pedestrians or cyclists ... advanced systems that are capable of detecting pedestrians and cyclists located in close proximity to the front or nearside of the vehicle and of providing a warning or avoiding collision with such vulnerable road users.”

8.7.1 Results from previous research

Høye et al. (2023) has summarized empirical evidence of the effectiveness of VRU-collision warning systems that are combined with AEB, based on empirical accident studies. On passenger cars, such systems can prevent about 20 percent of car-pedestrian collisions. For cyclists, no effect was found.

Studies that have investigated the effects of VRU-collision warning systems with AEB on buses, have not been found.

Theoretically, such systems may affect driver behavior negatively (drivers may become less alert for VRUs), but studies that have investigated such effects in real traffic were not found.

8.7.2 Relevance

Measures aimed at avoiding collisions with vulnerable road users are highly relevant. This is supported by accident data showing that a significant proportion of injuries involve collisions with vulnerable road users.

Table 8.7: Assessment of effects of warning systems for vulnerable road users and emergency braking.

Measure	Measure studied on buses?	Does the measure reduce accidents / injuries?	Target group of road users	How uncertain is the effect?	Is the measure in conflict with other measures?	Is the measure relevant?
Warning system for vulnerable road users and emergency braking	No, but on cars. 20% red. of ped accidents	Yes	VRUs	Medium	No	Yes
7.5	1	1.5		2	0	3

8.8 Emergency stop signal

Obligatory on all new buses from 2024 (EUR-Lex, 2022) is:

“Emergency stop signal ... a light-signalling function to indicate to other road users to the rear of the vehicle that a high retardation force is being applied to the vehicle relative to the prevailing road conditions”

We have no information about potential of actual effects on bus accidents and will thus not provide an assessment of this measure.

8.9 Tyre-pressure warning

Tyre-pressure warning will be mandatory on new buses from 2024 (EUR-Lex, 2022):

“Tyre pressure monitoring system ... a system fitted on a vehicle which can evaluate the pressure of the tyres or the variation of pressure over time and transmit corresponding information to the user while the vehicle is running”

We have no information about potential of actual effects on bus accidents or on how many bus accidents are due to low tyre pressure or defect tyres and will thus not provide an assessment of this measure.

9 Driver assistance systems – optional systems

This chapter describes driver assistance systems that are not mandatory for buses:

9.1 Electronic stability control (ESC) and roll stability control (RSC)

Electronic stability control (ESC) and roll stability control (RSC) aims at preventing loss-of-control accidents. Such accidents occur often in curves and on slippery roads.

For heavy trucks, empirical studies show that loss-of-control and rollover crashes are reduced between 25 and 60 percent. Studies that have investigated ESC or RSC on buses have not been found (Høye et al., 2022).

Table 9.1: Assessment of effects of Electronic Stability Control (ESC).

Measure	Measure studied on buses?	Does the measure reduce accidents / injuries?	Target group of road users	How uncertain is the effect?	Is the measure in conflict with other measures?	Is the measure relevant?
Electronic stability control (ESC)	No, results are only applicable to light cars	Yes, probably: can hinder skidding with buses	Everyone involved in accidents with buses	Low	No	Yes
7	1	1		3	0	2

9.2 Non-overridable ISA

Warning ISA will become mandatory on all buses from 2024, but not non-overridable ISA which makes it impossible to drive above the speed limit.

Non-overridable ISA would eliminate all speeding which can be expected to reduce accident and injury numbers. Elvik and Høye (2018) and Elvik (2019B) showed that full compliance with speed limits would reduce total road traffic fatalities by 22 percent, serious injuries by 15 percent and minor injuries by 9 percent.

To estimate potential effects of non-overridable ISA on buses, we would need information about the contribution of speeding to bus accidents (see the section about warning ISA).

Table 9.2: Assessment of effects of non-overridable ISA.

Measure	Measure studied on buses?	Does the measure reduce accidents / injuries?	Target group of road users	How uncertain is the effect?	Is the measure in conflict with other measures?	Is the measure relevant?
Non-overridable ISA	No	Yes, but uncertain how much	All	High	No	Yes
3	0	1		1	0	1

9.3 Geofence speed limiter

Geofence speed limiter is a system that is connected with ISA and that adjusts speed in digitally defined areas (Høye & Elvik, 2023). How it influences the drivers speed choice, depends on the type of ISA (informative or non-overridable).

Some trials have been done with geofence speed limiters on buses in Sweden. In summary, Høye and Elvik (2023) describe the trials as follows:

GFS on public buses around bus stops: GFS limited speed to max. 20 km/h around bus stops. According to the drivers who participated in the trial, falls on-board and collisions with other road users may be reduced. However, the system would also increase delays and may increase stress for the drivers. Thus, in its current form, this measure is not very “user-friendly” for bus drivers. We might, however, expect technological improvements, which could increase the user-friendliness for bus drivers, and in that case, this measure is likely to be very effective.

GFS on buses in areas with many VRUs: In another trial, GFS limited the buses’ speed in areas with many pedestrians and cyclists. Such a measure may reduce bus-VRU-collisions. However, the total number of accidents that may be affected is probably small.

Table 9.3: Assessment of effects of Geofence speed limiter.

Measure	Measure studied on buses?	Does the measure reduce accidents / injuries?	Target group of road users	How uncertain is the effect?	Is the measure in conflict with other measures?	Is the measure relevant?
Geofence speed limiter	No	Yes, but uncertain how much	All	High	Might lead to stress and delays. Uncertain how much.	Yes. Could prevent falls and collisions
3.5	0	1		1	0.5	2

9.4 Alcolock and “druglock”

In Norway, all buses and minibuses in licensed transport have an alcohol lock installed. For buses and minibuses that were registered before 1 January 2019, the deadline for retrofitting an alcolock in the vehicle is 31 December 2023. Alternatively, the vehicle must be taken out of service.⁶ EUR-Lex (2022) defines alcolock as follows:

‘alcohol interlock installation facilitation’ means a standardised interface that facilitates the fitting of aftermarket alcohol interlock devices in motor vehicles

Alcolock requires the driver to provide a negative breath test before starting the engine.

Drug ignition interlocks do the same as alcolock, but they require driver samples that are tested for other substances. While alcolock has been widely tested and applied in real traffic, drug locks are far less developed.

9.4.1 Previous research

Empirical evidence about the effects of alcolock is summarized by Høye (2022). Alcolock can theoretically eliminate all drunk driving. However, the system may be circumvented. Firstly, there has to be an “off” button that allows to start the engine when there is a technical error (such

⁶ <https://www.vegvesen.no/kjoretoy/yrkestransport/alkolas/>

circumventions are registered in the system). Secondly, the standard version of alcolock only prevents starting the engine, but not drinking while driving or during rest times, as long as the engine is not turned off. To prevent such drinking while driving, alcolock may require regular samples from the driver, which might be regarded as overly intrusive and possibly offensive by drivers of public buses.

Alcolock may theoretically also affect the amount of drug driving, but it is unknown how. Theoretically, the effect may generalize from alcohol to other drugs. On the other hand, some drivers may take other substances in replacement of alcohol.

Disadvantages with alcolock and drug lock are the amount of time required to start the engine, drivers may find it intimidating to provide breath tests in public, and there may be technical problems, especially when it is cold. Technical improvements may solve such disadvantages.

To assess the effects of alcolock on bus accidents, we would need information about the degree to which alcohol is a contributing factor. Previous studies indicate that this is a very low degree.

9.4.2 Relevance

The assessment of the relevance of alcolock and drug lock is limited by the lack of information about the amount of drunk and drug driving among bus drivers.

Table 9.4: Assessment of effects of alcolock and druglock.

Measure	Measure studied on buses?	Does the measure reduce accidents / injuries?	Target group of road users	How uncertain is the effect?	Is the measure in conflict with other measures?	Is the measure relevant?
Alcohol lock	Yes	Yes, probably small effect	All	Medium	No	Uncertain
6	2	2		2	0	0
Druglock	No	Yes, unknown effect size	All	Medium	No	Uncertain
5	2	1		2	0	0

9.5 Lane Departure Warning (LDW)

Lane departure warning and similar systems aim at avoiding accidents where the driver unintentionally departs from the driving lane. LDW will become mandatory on all new passenger cars, but not on heavy vehicles. However, it is common on public buses, for example in Oslo.

EUR-Lex (2022) described two such systems:

- *Lane departure warning: "... a system to warn the driver that the vehicle is drifting out of its travel lane"*
- *Emergency lane-keeping system: "... a system that assists the driver in keeping a safe position of the vehicle with respect to the lane or road boundary, at least when a lane departure occurs or is about to occur and a collision might be imminent"*

In practice, there are many different systems that differ in detail, such as how the driver is warned and the degree to which the vehicle may override the drivers' actions.

LDW is most effective when driving on rural roads and motorways. Most such systems require lane markings of quite good quality (Høye et al., 2022).

There is only scarce empirical evidence of the effects of LDW on buses. For driving in urban conditions, it has probably no effects as it usually only functions at higher speeds. However, there are also

so-called queue-assistants that can take over both lateral and longitudinal control. Such systems may however cause other problems such as monotony and sleepiness.

Empirical studies among passenger cars show that many drivers switch off LDW to avoid the warnings which are often regarded as very annoying. LDW on buses may produce even more warnings because buses are wider and will therefore produce more false alarms (or more failures to warn). False alarms from LDW may negatively impact the drivers' working conditions. LDW might, however, be more relevant for long distance buses travelling on main roads and highways.

Table 9.5: Assessment of lane departure warning.

Measure	Measure studied on buses?	Does the measure reduce accidents / injuries?	Target group of road users	How uncertain is the effect?	Is the measure in conflict with other measures?	Is the measure relevant?
LDW	No	Maybe, hardly in urban traffic, but probably in long distance bus transport.	All	Highly uncertain	No (but with general working conditions)	Uncertain
2	0	1		1	-1	1

9.6 Forward collision warning (FCW) and automatic emergency brake (AEB)

EUR-Lex (2022) describes:

‘advanced emergency braking system’ means a system which can automatically detect a potential collision and activate the vehicle braking system to decelerate the vehicle with the purpose of avoiding or mitigating a collision;

Such systems are not described by Høye et al. (2022). On passenger cars, relatively large reductions of rear-end collisions were found, especially on freeways.

How FCW and AEB would affect bus safety is unknown. In urban traffic the effect is probably limited, but it is likely to be different in regional and long-distance transport.

Table 9.6: Forward collision warning (FCW) and automatic emergency brake (AEB).

Measure	Measure studied on buses?	Does the measure reduce accidents / injuries?	Target group of road users	How uncertain is the effect?	Is the measure in conflict with other measures?	Is the measure relevant?
FCW/AEB	No, but for passenger cars	Relatively large reductions of rear-end collisions were found, especially on freeways.	All	Medium	No	Yes, to a large extent
8	0	3		2	0	3

9.7 Pedal application error avoidance

This is a driver assistance system that is activated when the driver mistakenly presses the accelerator instead of the brake pedal. This is probably a rare event, but potentially serious (Martin et al., 2019). Given little existing knowledge about this, we will not provide an assessment of this measure.

9.8 Runaway bus prevention

This is a system that prevents the bus from moving without the driver on the driver seat. This is probably a rare event, but potentially serious (Martin et al., 2019). Given little existing knowledge about this, we will not provide an assessment of this measure.

9.9 Connected traffic and weather warnings

Systems that share information between buses and possible infrastructure sensors may reduce the risk of accidents under unexpectedly difficult driving or traffic conditions. Given little existing knowledge about this, we will not provide an assessment of this measure.

10 Other measures

10.1 Improved visibility of buses

Buses are large but can still be overlooked by other road users. Two measures that can counteract this are contour marking and side marker lights.

Contour marking means that a retroreflective band is applied along the outer edge of the carriage body. Side marker lights have a similar function.

Høye et al. (2022) have summarized empirical evidence of the safety effects of such measures. Contour markings on heavy vehicles were found to reduce accidents in which the heavy vehicle is hit by another motor vehicle from the rear or side in the dark, by 20-40 percent. Side marking lights were found to reduce accidents in which the heavy vehicle is hit by another motor vehicle from the side in the dark, by 7 percent.

Assessing the potential impact of these measures on buses would require information about the proportion of relevant collisions in the dark.

Table 10.1: Assessment of effects of measures for improved visibility.

Measure	Measure studied on buses?	Does the measure reduce accidents / injuries?	Target group of road users	How uncertain is the effect?	Is the measure in conflict with other measures?	Is the measure relevant?
Measures for improved visibility	No, results are based on studies on trucks	7-20 % reduction in accidents in the dark	Everyone involved in accidents with buses	Low	No	Yes, particularly for collisions in the dark
8	1	2		3	0	2

10.2 Studded tires

Ruter's buses are not equipped with studded tires. Effects of studded tires on buses were assessed by Elvik (2019c). The existing knowledge is summarized as follows: Studded tires improve traffic safety, but the improvement is not substantial. Assuming the same effect for buses as for light vehicles, a bus equipped with studded tires may have a 2-10% lower accident risk than a bus without studded tires driven under the same road conditions.

ESC improves safety, nearly as much as studded tires. It has not been documented that electronic stability control leads to behavioral adaptation in the same way as studded tires, where drivers tend to drive slightly faster due to feeling safer with studded tires (thus "reducing" the achieved safety effect). Electronic stability control also does not have negative environmental impacts.

Equipping all buses in Norway with studded tires is not highly feasible. However, one possible solution could be to have some buses equipped with studded tires and deploy them on routes where road conditions are known to be particularly challenging and where the environmental impact is minimal due to dispersed settlements. Therefore, we consider studded tires as a measure for both class 1 (urban environment) and class 2 (regional traffic in more rural areas).

Table 10.2: Assessment of effects of studded tires for class 1 and class 2 buses.

Measure	Measure studied on buses?	Does the measure reduce accidents / injuries?	Target group of road users	How uncertain is the effect?	Is the measure in conflict with other measures?	Is the measure relevant?
Studded tires on class 1 buses	No	Could possibly lead to a slight decrease	Everyone involved in bus accidents	Medium	Yes, increased dispersion of particulate matter in urban environments	Yes, but applies to few injuries
4	0	1		2	-1	2
Studded tires on class 2 buses	No	Could possibly lead to a slight decrease	Everyone involved in bus accidents	Medium	Dispersion of particulate matter is likely a lesser problem in rural areas	Yes, but applies to few injuries
5	0	1		2	0	2

10.3 Technical defects and control

Technical defects on heavy vehicles, especially defects on brakes and tires, increase crash risk by about 50 percent (Høyve et al., 2022).

Technical inspections (as a roadside measure) were found to reduce heavy vehicle crashes by 12 percent if the number of inspections is increased by 50 percent (Høyve et al., 2022). Corresponding results for buses are not available. However, we might think of this as a measure that also can be done systematically and regularly by bus companies. Given little existing knowledge about this, we will not provide an assessment of this measure.

10.4 Evacuation from buses after accidents

There are several studies of evacuation from buses after accidents, e.g., related to school buses (e.g., Gunter et al 2020). We will not provide an assessment of this measure, as it cannot be labelled a traditional road safety measure. This is to some extent related to post crash care. We will, however, mention some main points briefly, as this issue related to measures that might reduce the consequences of accidents. An overview provided by the European Commission (2022) state that crash injury research shows that in serious crashes, bus passengers are hindered from using the emergency doors either because they are severely injured, or the doors are locked due to the impact. The overview provided by the European Commission (2022) states that it is important that the design of bus corridors enables rapid evacuation of bus occupants. Requirements to side windows are also mentioned: On the one hand, side windows should, even when broken, remain in position and act as a safety net keeping passengers in the bus interior. On the other hand, it should also be possible to eject windows easily after the bus has come to rest.

11 Summary and discussion

11.1 Ranking of measures

We have presented and discussed the effects of 33 different safety measures. In the review of each measure, we address the following questions: 1) Has the measure been studied in buses? 2) Does the measure reduce accidents or injuries? 3) Who benefits from the reduction in accidents or injuries? 4) How uncertain is the effect? 5) Does the measure conflict with other objectives? 6) Is the measure relevant to the traffic safety situation? We rank the measures based on effectiveness, using an evaluation where we assign points for each of the mentioned questions. Based on these calculations, we calculate a total score for each measure. Results of these rankings have been presented throughout the text and in Appendix 1 we provide a full and ranked list of all the measures and the qualitative and quantitative assessments.

The 12 measures that receive the highest scores are as follows:

- 1) Fleet management systems to facilitate a soft driving style (11.5 points)
- 2) Seat belts in Class 3 buses (10 points)
- 3) Safety culture measures (10 points)
- 4) Seat belts in class 2 buses (9 points)
- 5) Measures to increase seat belt use for bus drivers (8.5 points)
- 6) Blind spot warning (8 points)
- 7) Safety management system (8 points)
- 8) Crash protection for bus drivers (8 points)
- 9) Forward collision warning, Automatic Emergency Break (8 points)
- 10) Measures for improved visibility (8 points)
- 11) Warning system for vulnerable road users and emergency braking (7.5 points)
- 12) Electronic stability control (7 points)

Measure 2, 4, 5 and 8 are consequence reducing measures. Measure 1, 3 and 7 are organisational measures, related to system and culture. Measures 6, 9, 10, 11 and 12 are measures to reduce the probability of accidents occurring.

11.2 Ranking of measures within categories

Organisational management measures. There is generally less focus on safety culture and safety management in the road sector compared to other transport sectors. This is explained by the fact that road sector companies do not have the same legal requirements for safety management systems as in aviation, maritime sector, and railways. Despite legal requirements, several bus companies work systematically with safety management systems and safety culture, and our research indicates that this is related to positive safety outcomes. The same applies to another organisational safety management measure; working systematically with fleet management systems to ensure a soft driving style. This measure is related to positive safety outcomes, and it is relevant for several different types of injuries in bus transport, both applying to traffic accidents and non-collision passenger incidents onboard the bus. An important aim of the study is to rate the measures, based on whether they lead to reductions in accidents, uncertainty, and relevance. The

organisational management measures are among the bus safety measures with the highest overall rating: Fleet management system is rated as number one, safety culture measures as number three and safety management system as number seven.

Measures to reduce the occurrence of accidents. The five most effective and relevant measures studied, in addition to the three mentioned organisational measures are: blind spot warning and measures for improved visibility.

Measures to reduce the consequences of accidents. The five most effective and relevant measures studied are: seat belt in class 3 buses, increasing seat belt use for bus drivers, seat belt in class 2 buses, crash protection for bus drivers and seat belt in class 1 buses.

11.3 Limitations

It should be mentioned that our rating and assessment based on whether they lead to reductions in accidents, uncertainty, and relevance (i.e., fifth aim) is conservative and biased in the sense that we tend to rate existing and "older" measures higher. The reason is that there is more research on older measures, and thus more information on effects on accidents, less uncertainty, more well developed and user-friendly technology etc. We attempt to compensate for this bias by also highlighting measures which seem promising, but for which there is little relevant research, indicating need for future research.

It should also be noted that our analysis of incidents does not differentiate between levels of injury severity, as we lack data on this. Therefore, we cannot definitively conclude which measures are most relevant for preventing fatalities and serious injuries. It is likely, for example, that the "Traffic accident-collision" category involves more deaths than the "On-board injury-passenger" category.

11.4 Recommendations

Many of the measures that we rate are already legally required in bus transport and are thus implemented in companies. We rate them nevertheless, to provide an overview of efficiency and relevance. Several measures that are legally required get high ratings in our assessments. It is, however, of more relevance to provide recommendations based on efficient and relevant measures that are not legally required (yet), and which thus are not fully implemented. When it comes to such measures, some companies might have them, but not all, as the measures are not mandatory. Based on that, we recommend that the following measures are made mandatory in bus transport: 1) Fleet management systems to facilitate a soft driving style, 2) Safety culture measures, 3) Safety management systems, 4) Crash protection for bus drivers. These measures are not legally required in bus transport, although they are highly effective for preventing accidents. Safety culture measures and Safety management systems are required in other transport sectors, with a high safety level (e.g., aviation, rail, maritime sector). Measure 1-3 should be required by public transport authorities through contracts with bus operators. When it comes to measure 4, we recommend a separate European standard for collision safety in buses (instead of the current situation, which involves that buses are covered by regulations for other types of vehicles).

Other measures are already required, but not fully implemented in practice. Given their efficiency, a relevant step would be to find measures aiming to increase their implementation. This applies e.g., to measures to increase seat belt use among passengers in class 3 and 2 buses. This could be done by both national authorities and public transport authorities.

Additionally, there are also several measures which seem promising, but for which there is little relevant research, or the current versions of the technology might not seem fully developed yet. This indicates a need for further research. This applies e.g., to geofence speed limiter, run over guards,

Safety in bus transport in Europe

warning systems for vulnerable road users and emergency braking, pedestrian airbags, measures to prevent fall accidents on-board buses, measures to secure wheelchairs and baby buggies. These measures need to be further developed and examined by a range of key stakeholders in bus transport.

References

- Accident Investigation Board Norway (2013). *Report on the derailing by Nykirke station, Vestfoldbanen, February 15th, 2012, train 12926*. (Report JB 2013/02). Accident Investigation Board Norway
- Accident Investigation Board Norway (2019). *Report on collision between two buses on fv. 450 by Nafstad, Ullensaker November 17th 2017*. (Report Road 2019/04). Accident Investigation Board Norway.
- Albertsson, P., Falkmer, T., Kirk, A., Mayrhofer, E., & Björnstig, U. (2006). Case study: 128 injured in rollover coach crashes in Sweden – injury outcome, mechanisms and possible effects of seat belts. *Safety Science*, 44, 87-109.
- American Automobile Association. (2019). *Automatic emergency braking with pedestrian detection*. American Automobile Association.
- Amtrak. (2015). *Safety and security: Opportunities exist to improve the Safe-2-Safer program* (Audit Report OIG-A-2015-007). Amtrak.
- Antonsen, S. M., Nilsen, P. G., & Almklov, P. G. (2017). Regulating the intangible: Searching for safety culture in the Norwegian petroleum industry. *Safety Science*, 92, 232-240.
- Assum, T., & Erke, A. (2009). *Promillekjøring med tunge kjøretøy. Omfang, ulykkesrisiko og mulige tiltak*. (TØI report: 1021/2009). Institute of Transport Economics.
- Assum, T., & Hagman, R. (2006). *Alkolås i buss*. (TØI-Report: 842/2006). Institute of Transport Economics.
- Behrendorff, I., & Hansen, L. K. S. (1994). *Sidespejle på lastbiler - brug og effekt af nærzone- og vidvinkelspejle*. (RfT-rapport 1/1994). København, Rådet for Trafiksikkerhedsforskning.
- Bentama, A., Millot, M., Khatory, A. (2017) The victims of buses accidents in France: what exposure to risk? *Rech. Transp. Secur.* 33:31-39
- Berge, S. H., & Phillips, R. O. (2018). *Use of mobile phones by bus drivers: a sociotechnical approach*. (TØI report: 1661/2018). Institute of Transport Economics.
- Bjørnskau, T., & Longva, F. (2009). *Safety culture in transport*. (TØI report 1012/2009). Institute of Transport Economics.
- Bjørnskau, T., T.-O. Nævestad (2013), 'Safety culture and safety performance in transport: A literature review', Institute of Transport Economics (Oslo, Norway), TØI working paper 50267.
- Bjørnskau, T. (2020). *Risiko i veitrafikken 2017-2018*. Rapport 1782. Oslo, Transportøkonomisk institutt.
- Bjørnskau, T., & Ingebrigtsen, R. (2015). *Alternative understandings of risk and exposure*. (TØI Report 1449/2015). Institute of Transport Economics.
- Burgemeestre, J., Hulstijn, J., & Tan, Y. H. (2009). Rule-based versus principle-based regulatory compliance. *Proceedings of the 2009 conference on Legal Knowledge and Information Systems*.
- Charbotel, B., Martin, J. L., & Chiron, M. (2010). Work-related versus non-work-related road accidents: Developments in the last decade in France. *Accident Analysis and Prevention*, 42, 604-611.

- Cichocki, K., & Wekezer, J. W. (2007). Structural response of paratransit buses in rollover accidents. *International Journal of Crashworthiness*, 12, 217-225.
- Davey, J., Freeman, J., & Wishart, D. (2006). A study predicting crashes among a sample of fleet drivers. In *Road safety research, policing and education conference*, Gold Coast, Queensland.
- Duarte, G. O., Gonçalves, G. A., & Farias, T. L. (2013). Vehicle monitoring for driver training in bus companies—Application in two case studies in Portugal. *Transportation research part D: transport and environment*, 18, 103-109.
- Elvik, R., & Bjørnskau, T. (2005). How accurately does the public perceive differences in transport risks? An exploratory analysis of scales representing perceived risk. *Accident Analysis and Prevention*, 37(6), 1005-1011.
- Elvik, R. (2006). Economic deregulation and transport safety: A synthesis of evidence from evaluation studies. *Accident Analysis and Prevention*, 38, 678-686.
- Elvik, R., Høyve, A., Vaa, T., & Sørensen, M. (2009). *The Handbook of Road Safety Measures* (2nd ed.). Bingley, UK: Emerald Insight.
- Elvik, R. (2019). Risk of non-collision injuries to public transport passengers: Synthesis of evidence from eleven studies. *Journal of Transport and Health*, 13, 128-136.
- Elvik, R. (2019). A comprehensive and unified framework for analyzing the effects on injuries of measures influencing speed. *Accident Analysis and Prevention*, 125, 63-69.
- Elvik, R. (2019). *Effects of studded tires on the number of accidents - a knowledge summary*. (Working document SM/51469). Institute of Transport Economics.
- Elvik, R., & Høyve, A. (2018). *The potential to reduce the number of fatalities and seriously injured in traffic until 2030*. (TØI report 1645). Institute of Transport Economics.
- Englander, B., Cacic, M., & Diop, C. (2017). *Collision avoidance system for buses, managing pedestrian detection and alerts near bus stops*. Paper 17-0430 presented at the 25th annual technical conference on the enhanced safety of vehicles (ESV), Washington D.C., Transportation Research Board.
- ERA (2023), 'Safety Management System (SMS)', European Rail Agency, https://www.era.europa.eu/domains/safety-management/safety-management-system-sms_en, accessed 2023-04-02.
- EUR-Lex (2022). <https://eur-lex.europa.eu/legal-content/EN/ALL/?uri=CELEX:32019R2144>
- European Railway Agency. (2013). *Safety Unit Application guide for the design and implementation of a Railway Safety Management System: Developing and improving safety culture in the organization*. European Railway Agency.
- European Commission (2022) https://road-safety.transport.ec.europa.eu/eu-road-safety-policy/priorities/safe-vehicles/archive/buses-and-coaches_en
- Estache, A., & Gomez-Lobo, A. (2005). Limits to competition in urban bus services in developing countries. *Transport Reviews*, 25(2), 139-158.
- Flotve, B., Farstad, E., (2022). *Transportytelser i Norge 1946-2021*. Rapport 1929. Oslo, Transportøkonomisk institutt.
- Gepner, B., Bojanowski, C., Kwasniewski, L., & Wekezer, J. (2014). Effectiveness of ECE R66 and FMVSS 220 standards in rollover crashworthiness assessment of paratransit buses. *International Journal of Automotive Technology*, 15(4), 581-591.

- Goettee, D., Spiegel, W., Tarr, R., Campanian, C., & Grill, L. (2015). *Overview of Federal Motor Carrier Safety Administration Safety Training Research for New Entrant Motor Carriers*. The SAGE Corporation, Motor Carrier Services.
- Gregersen, N. P., B. Brehmer, B. Morén (1996), 'Road safety improvement in large companies. An experimental comparison of different measures', *Accident Analysis & Prevention*, 28(3), 297–306.
- Gunter, L. J. Davis, Y. Abulhassan, R. Sesek, S.Gallagher, M.Schall (2020) School bus rear emergency door design improvements to increase evacuation flow, *Safety Science*, Volume 121,
- Hesjevoll, I.S., F. Sagberg, A. Høy, R. Elvik (2022) Dødsulykker innenfor og utenfor Nullvisjonens systemgrenser, TØI-rapport 1887/2022, Oslo: Transportøkonomisk institutt
- Hickman, J. S., & Geller, E. S. (2003). Self-management to increase safe driving among short-haul truck drivers. *Journal of Organizational Behavior Management*, 23(4), 1-20.
- Hickman, J. S., & Hanowski, R. J. (2011). Use of a video monitoring approach to reduce at-risk driving behaviors in commercial vehicle operations. *Transportation Research Part F: Traffic Psychology and Behaviour*, 14(3), 189-198.
- Hudson, P. (2003). Applying the lessons of high-risk industries to health care. *Quality and Safety in Health Care*, 12, i7–i12.
- Høy, A.K. (2022). Impaired driving and road safety. TØI-Report 1925/2022.
- Høy, A.K., Hesjevoll, I.S.; / Vaa, T. (2015). Førerstøttesystemer - Status og potensial for fremtiden. TØI-Rapport 1450/2015.
- Høy, A.K. & Elvik, R. (2023). Trafikksikkerhetseffekter av geofence fartssperre. TØI-Arbeidsdokument.
- Høy, A.K., Elvik, R., & Nævestad, T.O. (2022). Trafikksikkerhet for tunge kjøretøy. TØI-rapport 1927/2022.
- Høy, A. (2011). The effects of Electronic Stability Control (ESC) on crashes: An update. *Accident Analysis and Prevention*, 43, 1148-1159.
- Høy, A. (2016). How would increased seat belt use affect the number of killed or seriously injured light vehicle occupants? *Accident Analysis and Prevention*, 88, 175-186.
- Høy, A., et al. (2020) *The Handbook of Road Safety Measures*. Institute of Transport Economics. Retrieved from: <https://www.tshandbok.no/>
- IATA. (2019). Creating a positive safety culture: Best practices to align with Annex 19's new recommendations. Retrieved from: https://go.updates.iata.org/safety-culture?_ga=2.26439165.1941341082.1571071913-370565390.1570852392
- Jongpradist, P., Saingam, N., Tangthamsathit, P., Chanpaibool, P., Sirichantra, J., & Aimmanee, S. (2022). Crashworthiness analysis and design of a sandwich composite electric bus structure under full frontal impact. *Heliyon*, 8(12). <https://www.sciencedirect.com/science/article/pii/S240584402203287X>
- Jongpradist, P., Senawat, S., & Muangto, B. (2015, August). Improvement of crashworthiness of bus structure under frontal impact. In *The 2015 World Congress on Advances in Structural Engineering and Mechanics (ASEM15)* Incheon, Korea. http://www.i-asem.org/publication_conf/asem15/8.ICACD15/T3H.2.CD451_1831F1.pdf
- Kendrick, D., Drummond, A., Logan, P., Barnes, J., & Worthington, E. (2015). Systematic review of the epidemiology of non-collision injuries occurring to older people during use of public buses in high-income countries. *Journal of Transport & Health*, 2, 394-405.

- Kennett, P., Rechner, G., Childs, A., Hajj, M., & Grzebieta, R. (2016, September). Replacement Windscreens—a serious vehicle and road safety issue. In Australasian Road Safety Conference, 2016, Canberra, ACT, Australia.
<https://acrs.org.au/files/papers/arsc/2016/Kennett%2000059%20EA.pdf>
- Kourtellis, A., Lin, P.-S., & Lee, C. (2011). Evaluation of video camera system to reduce side collisions of transit buses. *Transportation Research Record*, 2265, 3-12.
- Krogstad, J., Phillips, R. O., & Berge, S. H. (2019). Public transport for all: The role of bus drivers. (TØI report 1683/2019). Institute of Transport Economics.
- Kwasniewski, L., Bojanowski, C., Siervogel, J., Wekezer, J. W., & Cichocki, K. (2009). Crash and safety assessment program for paratransit buses. *International Journal of Impact Engineering*, 36, 235-242.
- Lappalainen, F. J., Kuronen, J., & Tapaninen, U. (2014). Evaluation of the ISM Code in the Finnish shipping companies. *Journal of Maritime Research*, 9(1), 23–32.
- Lund, J. (2019). Helsevesenbasert skaderegistrering som verktøy for å forebygge trafikkulykker. Rapport. Oslo, Trygg Trafikk.
- McNeil, S., Thorpe, C., & Mertz, C. (2000). *A new focus for side collision warning systems for transit buses*. Paper presented at the Intelligent Transportation Society of America's tenth annual meeting and exposition.
- Martin, P., Guy, I. Carroll, J., Radcliffe, J., Hunt, R., Dold, M., Knight, I., Edwards, A., & McCarthy, M. (2019). The Transport for London Bus Safety Standard: Vulnerable Road User (VRU) Frontal Crashworthiness. TRL, Published Project Report PPR977.
- Mooren, L., Grzebieta, R., Williamson, A., Olivier, J., & Friswell, R. (2014a). Safety management for heavy vehicle transport: A review of the literature. *Safety Science*, 62, 79-89.
- Mooren, L., Williamson, A., Friswell, R., Olivier, J., Grzebieta, R., & Magableh, F. (2014b). What are the differences in management characteristics of heavy vehicle operators with high insurance claims versus low insurance claims? *Safety Science*, 70, 327-338.
- Murray, W., Ison, S., Gallemore, P., & Nijjar, H. S. (2009). Effective Occupational Road Safety Programs: A Case Study of Wolseley. *Transportation Research Record*, 2096, 55-64
- Murray, W., White, J., & Ison, S. (2012). Work-related road safety: A case study of Roche Australia. *Safety Science*, 50(1), 129-137.
- Musicant, O., Lotan, T., & Toledo, T. (2007). *Safety correlation and implications of an in-vehicle data recorder on driver behavior*. Paper presented at the TRB conference.
- Musicant, O., Lotan, T., & Albert, G. (2015). Do we really need to use our smartphones while driving? *Accident Analysis and Prevention*, 85, 13-21.
- Myers, L. A., Russi, C. S., Will, M. D., & Hankins, D. G. (2012). Effect of an onboard event recorder and a formal review process on ambulance driving behavior. *Emergency Medicine Journal*, 29(2), 133-135.
- Naveh, E., & Marcus, A. (2007). Financial performance, ISO 9000 standard and safe driving practices effects on accident rate in the U.S. motor carrier industry. *Accident Analysis and Prevention*, 39(4), 731–742.
- Naveh, E., & Katz-Navon, T. (2015). A longitudinal study of an intervention to improve road safety climate: Climate as an organizational boundary spanner. *Journal of Applied Psychology*, 100(1), 216-226.

- Newnam, S., & Oxley, J. (2016). A program in safety management for the occupational driver: Conceptual development and implementation case study. *Safety Science*, *84*, 238–244.
- Nævestad, T.-O. (2010). Cultures, crises and campaigns: Examining the role of safety culture in the management of hazards in a high-risk industry. Ph.D. dissertation, Centre for Technology, Innovation and Culture, Faculty of Social Sciences, University of Oslo.
- Nævestad, T. O., Blom, J., & Phillips, R. O. (2018a). *Safety culture, safety management, and risk in road freight transport companies*. (TØI report 1659/2018). Institute of Transport Economics.
- Nævestad, T.-O., Phillips, R. O., & Storesund Hesjevoll, I. (2018b). How can we improve safety culture in transport organizations? A review of interventions, effects, and influencing factors. *Transportation Research Part F: Traffic Psychology and Behaviour*, *54*, 28–46.
- Nævestad, T.-O., Phillips, R. O., Milch, V. (2019a). *How can Ruter work with traffic safety? A qualitative study*. (TØI report 1709/2019). Institute of Transport Economics.
- Nævestad, T.-O., Phillips, R. O., Laiou, A., Bjørnskau, T., & Yannis, G. (2019b). Safety culture among bus drivers in Norway and Greece. *Transportation Research Part F: Traffic Psychology and Behaviour*, *64*, 323–341.
- Nævestad, T.-O., Hesjevoll, I. S., Ranestad, K., & Antonsen, S. (2019c). Strategies regulatory authorities can use to influence safety culture in organizations: Lessons based on experiences from three sectors. *Safety Science*, *118*, 409–423.
- Nævestad, T.-O., Milch, V., Karlsen, K., Phillips, R. O., Elvik, R. (2020). Trafikksikkerhet i busstransport: En analyse av kravene som Ruter stiller til bussoperatørene i kontrakter. Rapport 1787. Oslo, Transportøkonomisk institutt, 2020
- Nævestad, T.-O. (2022) Eco driving as a road safety measure: Before and after study of three companies, *Transportation Research Part F: Traffic Psychology and Behaviour*, 91
- Olson, R., Anger, W. K., Wipfli, D. L., & Gray, M. (2009). A new health promotion model for lone workers: Results of the safety & health involvement for truckers (SHIFT) pilot study. *Journal of Occupational and Environmental Medicine*, *51*(11), 1233–1246.
- Palacio, A., Tamburro, G., O'Neill, D., & Simms, C. K. (2009). Non-collision injuries in urban buses – strategies for prevention. *Accident Analysis and Prevention*, *41*, 1-9.
- Pedro, M. J. G., & Macario, R. (2016). A review of general practice in contracting public transport services and transfer to BRT systems. *Research in Transportation Economics*, *59*, 94-106.
- Phillips, R. O., & Bjørnskau, T. (2013). *Health, safety, and bus drivers*. (TØI Report 1279/2013), Institute of Transport Economics.
- Reason, J. (1997), *Managing the Risk of Organisational Accidents* (Aldershot, UK: Ashgate).
- Sagberg, F., & Sætermo, I. A. (1997). *Traffic safety of tram transport in Oslo*. (TØI Report 367/1997). Institute of Transport Economics.
- Schein, E. (2004), *Organizational Culture and Leadership* (San Francisco, CA: Jossey-Bass)
- Salminen, S. (2008). Two interventions for the prevention of work-related road accidents. *Safety Science*, *46*, 545–550.
- Tung.no (2023). Lastebilssikkerhet: Disse førerassistentene er påbudt fra juli 2024. https://www.tungt.no/article/view/1025792/lastebilssikkerhet_disse_forerassistentene_er_pabudt_fra_juli

- The Norwegian Public Roads Administration, (2021). *Vedlegg 1. Høringsnotat. Høring om forslag til forskrift om endring i forskrift 3. desember 2009 nr. 1438 om universell utforming av motorvogn i løyvepliktig transport mv.* Norwegian Public Roads Administration.
- The Norwegian Public Roads Administration et al. (2019). *Traffic development 2018. Trafikksikkerhetsutviklingen 2018. Follow-up of National Action Plan for Road Safety.* The Norwegian Public Roads Administration.
- Thomas, M. J. W. (2012). *A systematic review of the effectiveness of safety management systems.* (Report no. AR-2011-148). Australian Transport Safety Bureau.
- Toledo, T., Musicant, O., & Lotan, T. (2008). In-vehicle data recorders for monitoring and feedback on drivers' behavior. *Transportation Research Part C, 16*, 320–331.
- Toledo, G. Y., & Shiftan, Y. (2016). Can feedback from in-vehicle data recorders improve driver behavior and reduce fuel consumption? *Transportation Research Part A: Policy and Practice, 94*, 194-204.
- Vaa, T. (1993). *Person injury and risk associated with bus travel. Revised calculations.* (TØI report 160/1993). Institute of Transport Economics.
- Wallington, D., Murray, W., Darby, P., Raeside, R., & Ison, S. (2014). Work-related road safety: Case study of British Telecommunications (BT). *Transport Policy, 32*, 194-202.
- Wouters I. J. & Bos, J. M. (2000). Traffic accident reduction by monitoring driver behaviour with in-car data recorders. *Accident Analysis and Prevention 32*(5), 643-50.

Appendix

Appendix 1. Overview of assessed measures

Table A.1.1: Overview of assessed measures.

Measure	Measure studied on buses?	Does the measure reduce accidents / injuries?	Target group of road users	How uncertain is the effect?	Is the measure in conflict with other measures?	Is the measure relevant?
1) Fleet management system to facilitate soft driving style	Yes	Yes, up to 20% fewer traffic accidents	Drivers and passengers	Low to medium	No, but it could also lead to less fuel consumption and reduced carbon omission	Yes, particularly passenger injury, often resulting from harsh breaking
Score: 11.5	2	3		2.5	+1	3
2) Seat belts in Class 3 buses	Yes, but limited studies	Possible reduction of 30-40% for all	Seated passengers and drivers	Medium	No	Yes, collision are associated with the highest accident rates
Score: 10	2	3		2	0	3
3) Safety culture measures	Yes	Yes	People on buses and other road users	Medium	Uncertain, probably not	Yes
Score: 10	2	3		2	0	3
4) Seat belts in class 2 buses	Yes, but there are few studies	Potential injury reduction of 30-40% for seated passengers (60% of passengers)	Seated passengers and bus driver	Medium	No	Yes, collisions have the second largest number of injuries
Score: 9	2	2		2	0	3
5) Increasing seat belt use for bus drivers	No, for truck drivers, but should be relatively comparable	Yes, but difficult to quantify	Bus drivers	Low	No	Yes, but not the largest portion of injuries, and only for a small <u>unknown</u> share of non-users
Score: 8.5	1.5	3		3	0	1
6) Blind spot warning	Yes, but predominantly as technical trials	Yes, probably; difficult to quantify	Vehicles and vulnerable road users residing in the bus' blind spots	Medium	No	Yes, potential other vehicles in the blind spot and vulnerable road users
Score: 8	2	1		2	0	3

Safety in bus transport in Europe

Measure	Measure studied on buses?	Does the measure reduce accidents / injuries?	Target group of road users	How uncertain is the effect?	Is the measure in conflict with other measures?	Is the measure relevant?
7) Safety management system	Yes, likely	Likely reduction, implementation dependent	People on buses and other road users	Medium, because it is difficult to pinpoint what elements are most important	Uncertain, probably not.	Yes, and it can be adapted to specific risk categories
Score: 8	1	2		2	0	3
8) Crash protection for bus drivers	Yes, trials have been conducted	Likely reduction, difficult to quantify	Bus drivers	Medium	Increase in weight may occur	Yes, but not the largest portion of injuries
Score: 8	2	1		2	0	3
9) Forward collision warning, Automatic Emergency Break	No, but for passenger cars	Relatively large reductions of rear-end collisions were found, especially on freeways.	All	Medium	No	Yes, to a large extent
Score: 8	0	3		2	0	3
10) Measures for improved visibility	No, results apply to trucks	7-20% decrease in accidents in the dark	All parties involved in bus accidents	Low	No	Yes, particularly for collisions in the
Score: 8	1	2		3	0	2
11) Warning system for vulnerable road users and emergency braking	No, but on cars. 20% red. of ped accidents	Yes	VRUs	Medium	No	Yes
7.5	1	1.5		2	0	3
12) Electronic stability control	No, results are only applicable to light vehicles	Yes, likely, can prevent skidding in buses	All parties involved in bus accidents	Low	No	Yes, maybe run-off-road collisions
Score: 7	1	1		3	0	2
13) Alcohol lock	Yes	Yes, probably small effect	All	Medium	No	Uncertain
Score: 6	2	2		2	0	0
14) Studded tires on class 2 buses	No	Could possibly lead to a slight decrease	Everyone involved in bus accidents	Medium	Dispersion of particulate matter is likely a lesser problem in rural areas	Yes, but applies to few injuries
Score: 5	0	1		2	0	2
15) Measures to prevent fall accidents	Yes, but measures are hypothetical	Maybe, quantification is impossible	Standing passengers; passengers embarking/disembarking	High	Weaker acceleration/retardation could result in longer trip duration	Yes, applies to a large portion of injuries, but uncertain what the exact measure is
Score: 5	1	1		1	-1	3
16) Druglock	No	Yes, unknown effect size	All	Medium	No	Uncertain
Score: 5	2	1		2	0	0

Measure	Measure studied on buses?	Does the measure reduce accidents / injuries?	Target group of road users	How uncertain is the effect?	Is the measure in conflict with other measures?	Is the measure relevant?
17) Seat belt in class 1 buses	Yes, but there are few studies	Potential injury reduction of 30-40% for seated passengers, but few seats and complicating factors	Seated passengers and bus driver	Medium	Yes, possible conflict with accessibility/regularity for class 1 buses	Yes, maybe
Score: 5	2	1		2	-1	1
18) Warning ISA	No	Could possibly lead to a slight decrease	Everyone involved in accidents with buses	Low	No. Lower speeds might reduce emissions.	No
Score: 5	0	1		3	+1	0
19) Blind spot monitoring / warning	Not in real-world accident studies	Yes, probably; difficult to quantify	Other motor vehicles and VRUs	Highly	No	Yes
Score: 5	2	1		1	0	1
20) Intelligent Speed Adaptation (ISA)	No	Could possibly lead to a slight decrease	Everyone involved in accidents with buses	Low	No	No
Score: 4	0	1		3	0	0
21) Studded tires on class 1 buses	No	Could possibly lead to a slight decrease	Everyone involved in accidents with buses	Medium	Yes, increased dispersion of particulate matter in urban environments	Yes, but applies to few injuries
Score: 4	0	1		2	-1	2
22) Measures to secure wheelchairs and baby buggies	Not in real-world accident studies	Probably	All passengers	Highly, and the measure is not well-defined	No	Yes
Score: 4	0	1		1	0	2
23) Passenger seat back design	Not in real-world accident studies	Probably	All passengers	Highly, and the measure is not well-defined	No	Yes
Score: 4	1	1		1	0	1
24) Geofence speed limiter	No	Yes, but uncertain how much	All	High	Might lead to stress and delays. Uncertain how much. Currently not very user friendly for drivers.	Yes. Could prevent falls and collisions
Score: 3.5	0	1		1	0.5	2
25) Run-over guards / pedestrian airbags	No	Yes, but not quantified	VRUs hit by buses	Highly	No	Yes
Score: 3	0	1		1	0	1
26) Non-overrideable ISA	No	Yes, but uncertain how much	All	High	No	Yes
Score: 3	0	1		1	0	1
27) Design and positioning of handrails	Not in real-world accident studies	Probably	All passengers	Highly, and the measure is not well-defined	No	Yes
Score: 3	0	1		1	0	1

Safety in bus transport in Europe

Measure	Measure studied on buses?	Does the measure reduce accidents / injuries?	Target group of road users	How uncertain is the effect?	Is the measure in conflict with other measures?	Is the measure relevant?
28) Front end design	Not in real-world accident studies	Yes, but not quantified	VRUs hit by buses	Highly	No (except partly with itself)	Yes
Score: 3	0	1		1	0	1
29) Top speed limiter	No	Yes, perhaps in some cases	All	High	No	Difficult to assess
Score: 3	0	1	0	1	0	1
30) Reversing detection	No	Maybe	Everyone involved in accidents with buses	Low	No.	Yes maybe
Score: 3	0	1		1	0	1
31) Event data recorder	Maybe	Unknown	All	Highly	No	Uncertain due to lack of evidence
Score: 2.5	0.5	0	All	1	0	1
32) Lane departure warning	No	Maybe, hardly in urban traffic, but probably in long distance bus transport.	All	Highly uncertain	No (but with general working conditions)	Uncertain
Score: 2	0	1		1	-1	1
33) Driver distraction warning	No	Unknown	All	Highly	No	Uncertain due to lack of evidence
Score: 2	0	0	All	1	0	1

Appendix 2. Interview results

We have conducted qualitative research interviews and informal discussions with procurers of public transport in Norway, to obtain information about the state of the art within bus safety measures. We also obtained information about the types of measures required by procurers of bus transport in Norway, including variation among them when it comes to requiring e.g., more than what is required by the law. In the following, we provide overview of the measures required by Norway's largest public transport authority (Ruter), covering over half of all public transport in Norway. This is the public transport authority which has the most comprehensive requirements to road safety in Norway. Thus, it has influence over the other Norwegian transport authorities.

Organizational measures

Safety management systems and measures to improve safety culture required by Ruter are:

- Required for all buses as a part of the task description ("oppdragsbeskrivelse"): Safety management system ("sikkerhetsstyringssystem»), including measures for improving safety culture and learning
- Some differences between contractors (bus operators)
- Large improvements during the last years

Fleet management systems are not required. However, economic driving is part of task description ("oppdragsbeskrivelse").

Onboard passenger safety

Seat belts for passengers

Passenger seat belts are required for all class 2 buses. Specific requirements for passenger seat belts:

- Three-point belts
- Length requirement
- Adjustable height

Passenger seat belts are normally not required on class 1 buses. However, passenger seat belts are required on some class 1 buses with regional driving, depending on the type or roads they are driving on (also three-point belts)

Seat belt reminders for passengers are required on all buses with passenger seat belts. These provide collective reminders for all passengers with signs and sound about the requirement to use seat belts. Individual warnings for unbelted passengers are NOT included.

Design of passenger seat backs

High seat backs with included neckrest are required on all buses.

Seats and seat backs are evaluated for comfort

All materials are generally evaluated "from a safety perspective", but no specific requirements are given.

There is no requirement with respect to collision safety (e.g. injury risk in accidents where passenger hits a seat back with his head).

Crash-friendly design and positioning of handrails

No requirements for collision safety (e.g., passenger head hits handrail).

All handles / handrails must be visible (yellow).

Different practices: mostly vertical handles / handrails, either from floor to roof or from seat back to roof

Focus is mostly on attractivity and “flow”, i.e., passengers should easily move through the bus without hindrance

Securing wheelchairs and baby buggies

There are the following requirements.

- All buses must have at least three belts to secure baby buggies (or bicycles)
- All buses must have two child seats
- Class 1 buses must have seat back and belt for securing wheelchairs against driving direction, and they must comply with current regulations.
- Class 2 buses (and some class 1 buses with regional driving) must have devices for securing wheelchairs to the floor (which normally requires assistance)

There is a general discussion about wheelchair securing in buses. Passenger preferences are unclear; some prefer being self-helped and some prefer to be secured as good as possible.

Measures to prevent fall accidents

The only requirement is that passengers need something to hold on, but there are no specific requirements for design of handrails etc.

Other requirements include:

- Skid resistant floor
- Contrast marking of height differences on the floor
- Lighting of doors according to current regulation

Measures against falling accidents include mainly safety culture, driving style etc.

Crashworthiness and driver protection

Bus crashworthiness

Requirements for bus crashworthiness include:

- ECE-R29: collision protection in front; steel beam prevents intrusion into the driver compartment
- ECE-R66: rollover protection bars; mandatory by law for all class 2 buses, and required also for class 1 buses with regional driving
- ECE-R58 and R93: Under-run guards front and rear, targeting bus-passenger car collisions (not VRU)

Reinforced A- and B-beams and side are evaluated.

Seat belts and increasing seat belt use among bus drivers

All buses must have three-point height-adjustable seat belts for the driver (mandated by law).

Seat belt reminder for bus drivers is also mandated by law

Crash protection for vulnerable road users

There is **no** requirement of VRU collision protection, such as run-over guards, pedestrian airbags or a front-end design that mitigates injury or reduces run-over risk.

Side mirrors may be removed because of the requirement for digital mirrors.

Driver assistance systems: Required and optional systems

The following table gives an overview of systems that are required by Ruter or that are optional. Optional systems may be assessed positively. The table also states which systems are or will be mandated by law. Since systems may be mandated from 2024 or later years, systems may be “mandated by law” but not required by Ruter.

There is a general requirement of designing the drivers are ergonomically, including the design of monitors and switches.

The table is only meant to give a rough overview and not detailed information about rules and regulations; for example, requirements by law or by Ruter may refer to different versions of the systems.

System	By law (now or future)	By Ruter (now)	Comment
Top speed limiter	Required	Required	Class 1 buses: Top speed 70 km/t required Class 2 buses: Top speed 80 km/t required
ISA - warning	Required	Optional	
ISA - non-overrideable	Not required	Optional	
Geofence speed limiter	Not required	Optional	May be applied for example around schools. Required by other PTAs in some enclosed areas.
Reversing detection	Required	Required	Also required by Ruter: Reversing camera and white noise while backing required on all buses (must be overrideable by the driver) Parking sensors are not required
Driver distraction warning	Required	Optional	Present on all buses in Oslo: These systems detect and warn for fatigue, but not distraction (such as mobile phone use); some systems only warn the driver, some also notify the dispatch center This measure is frequently discussed by labor unions, there is some skepticism because of perceptions of driver surveillance.
VRU-collision warning and automatic emergency brake (AEB)	Required	Required / optional	Requirements: All doors and the areas around the doors (outside) must be visible for the driver (mirrors and/or camera) Blind zone warning right, left, and front (detects and notifies about cars and VRU); cyclist detection on the right side of the bus is mentioned specifically in Vedlegg 2. Digital mirrors 360-degree camera (or similar) Door camera (inside) Optional: VRU-AEB
ESC	Not required	Optional (recommended)	Present on most buses Problematic and often not present on articulated buses, although these would benefit most from ESC
Lane departure Warning (LDW)	Not required	Optional (recommended)	LDW is not required but recommended and relatively common. Different types of LDW may be used. LDW often needs some initial adjustments to avoid too frequent warnings, but no big problems have been reported.
Alcolock	Not required	Required	All buses must be equipped with an EU-approved alcolock: Each driver has a personal mouthpiece, positive test results are directly notified to the dispatch center; the engine can be turned off up to 15 minutes without requiring new test, after 15 minutes the system is reset and requires a new test (mostly relevant when changing between drivers)

System	By law (now or future)	By Ruter (now)	Comment
Blind spot monitoring and warning systems	Not required	Required	
Tire-pressure warning	Not required	Required	
Snow chains	Not required	Required	
Emergency equipment		Required	Includes fire extinguisher, first aid kit, emergency hammer or pin
Automatic fire extinguishing system	Not required	Required	Required on all buses with a combustion engine; Electric buses must have a surveillance system and / or fire extinguishing equipment for components that may be exposed to heat development or fire
Head-up display	Not required	Optional (recommended)	Recommended
Forward collision warning (FCW)	Not required	Optional	
Automatic emergency brake (AEB)	Not required	Optional	
Driver behavior monitoring & feedback	Not required	Optional	Such systems are discussed in combination with fleet management systems / distraction warning
Emergency stop signal	Not required	Optional	Pulsating braking lights
Event data recorder	Not required	Optional	
Ice warning	Not required	Optional	
CC and ACC			
Pedal application error avoidance			
Runaway bus prevention			Vedlegg 2 describes in detail how the bus is prevented from driving without the driver on the driver seat.
Warning in case of open lids			
Traffic sign recognition			

Other measures – required

- AVAS: All electric buses must be equipped with AVAS (Acoustic Vehicle Alerting System) which also is mandated by law since 2021.
- It must be assured that the bus cannot drive unless all doors are properly closed, and the doors must not open before the bus has come to a complete stop.
- All buses must have an emergency button for the driver

Other measures - optional

- Speed limited when too close to fixed object
- Detection and warning in case of high temperature (fire) outside
- Smooth start to prevent falls on board (especially on electric buses)
- Smooth curve driving
- Rain sensors
- Extra front lights / curve lights
- Sand (for spreading on icy roads)
- CCTV camera surveillance (not directly safety relevant)

Studded tires are normally **not** allowed, except when regarded as necessary.

TØI is an applied research institute that carries out research and study assignments for businesses and public agencies. TØI was established in 1964 and is organized as an independent foundation. TØI develops and disseminates knowledge about transport with scientific quality and practical application. The department has an interdisciplinary environment with 90+ highly specialized researchers.

The department conducts research dissemination through TØI reports, articles in scientific journals, books, seminars, as well as posts and interviews in the media. The TØI reports are available free of charge on the department's website www.toi.no.

The institute participates actively in international research collaboration, with particular emphasis on the EU framework programs.

TØI covers all means of transport and thematic areas within transport, including traffic safety, public transport, climate and environment, tourism, travel habits and travel demand, urban planning, ITS, public decision-making processes, business transport and general transport economics.

The Department of Transport Economics requires copyright for its own work and emphasizes acting independently of the clients in all professional analyses and assessments.

Postal Address:

Institute of Transport Economics
Gaustadalléen 21
N-0349 Oslo
Norway

Email: toi@toi.no

Business Address:

Forskningsparken
Gaustadalléen 21

Web address: www.toi.no

